

G.E.T. & BUCKETS



 avalanche  penetrator  twistlok
 defender  penetrator^{max}  twistlok^{pro}

Our Innovation. Your Advantage.



BRADKEN KNOWS THE MINING MARKET



Bradken has been manufacturing Ground Engaging Tools (GET) and buckets for the global mining market for more than 60 years. Our products are designed to suit mining class front-end loaders, hydraulic excavators and face shovels and can be customised to suit even the most challenging site specific requirements.

OUR BUSINESS

Bradken is a global manufacturer of differentiated capital and consumable products to the mining, transport, general industrial and contract manufacturing markets with a sales and distribution network servicing customers around the world.

As a leading heavy engineering company we can manufacture fully machined cast iron and steel products from a mass of 0.5 kg (1.1lbs) to 25 tonne (55,000 lbs). Bradken produces consumable wear products for all types of earthmoving equipment to the global mining and quarrying industries. Our products include:

- Ground Engaging Tools (GET) and associated wear parts,
- Dragline rigging packages,
- A range of buckets to suit dragline, front-end loader, face shovel and hydraulic excavator equipment, and
- Undercarriage systems and componentry for hydraulic mining excavators and electric rope shovels.

Our experienced engineering team is able to adapt our range of Bradken designed products to address the specific requirements and challenges presented by the diversity of the global mining market.

EXPERIENCE

With over 90 years' experience in the foundry business, the accumulated wealth of knowledge and depth of expertise in our workforce enables us to offer our customers a full service offering with design, manufacturing, maintenance and support services ultimately providing improved operational outcomes and safer work practices.

DESIGN

Our range of Ground Engaging Tools (GET), Buckets and Rigging have been designed and manufactured by our skilled and experienced team to provide quality and innovation that in turn provides our customers with reductions attributed to their Total Cost of Ownership (TCO), whilst providing improved safety features to reduce the risk of injury at site.

CAPACITY

With a worldwide network of foundry and manufacturing facilities and an established sales and distribution network, our geographical diversity allows us to provide product, technical support and advice, and exemplary service to customers in the world's major mining and industrial regions.





EXCAVATOR BUCKETS

Purpose : Bradken Avalanche™ Excavator Buckets are designed to meet customers' production and maintenance requirements.



R9400

The Avalanche Excavator Bucket provides quality, reliability and performance for when it comes to stripping out overburden, loading loose material, top loading or mass excavating.

OEM : Avalanche Buckets are engineered to suit OEM connections without the need for modification.

Size : Buckets range in size from 5m³ to >45m³ (6.5yd³ to >58.9yd³) capacities, while our customised range offers buckets to suit site specific production and maintenance requirements.

Tailored for : All Bradken Avalanche buckets, wear packages and GET can be tailored for use in General Purpose or Mining Class XHD (Extra Heavy Duty) applications.

Features	Advantages	Benefits
Innovative formed beam arrangement	Reduction in torsional effect improves bucket strength and durability	Increased bucket life Reduced maintenance costs
Multiple taper design	Improved loading and cleaner dumping Less wear on the rear of the bucket	Improved production Increased bucket life Reduced maintenance costs
One piece side reinforcing plate	Increased durability	Reduced maintenance costs
Corner gussets	Increased structural strength	Reduced maintenance Less downtime





FACE SHOVEL BUCKETS

Purpose : Bradken designs and manufactures a range of jaw fronts and doors for large hydraulic face shovel machines.

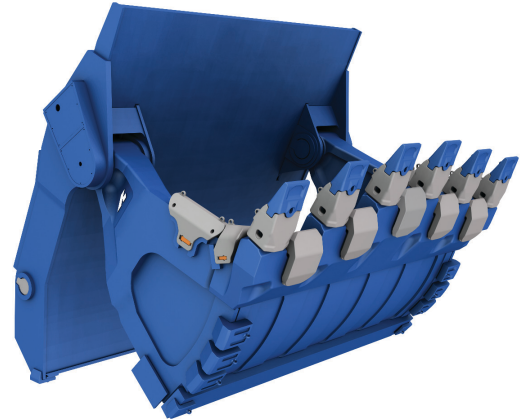

OEM : Bradken Avalanche™ Face Shovel Buckets are engineered to suit OEM connections without the need for modification and utilise the Penetrator™ cast lip system.

Size : Our standard offering covers buckets with 15m³ to >50m³ (19.6yd³ to >65.4yd³) capacities, while our customised range offers buckets to suit site specific production and maintenance requirements.

Tailored for : All Bradken Avalanche buckets, wear packages and GET can be tailored for use in General Purpose or Mining Class XHD (Extra Heavy Duty) applications.

Features	Advantages	Benefits
One piece castings	Elimination of weld joints in critical hinge neck regions	Reduced maintenance costs
Compatible with OEM hitch points	Simple maintenance and hook-up	Minimal downtime Low maintenance
Load distribution skeleton	Increased strength	Reduced maintenance costs Increased bucket availability
Optimised bucket capacities	High fill factors	Increased production

Registered Trademarks: All company names, logos, product names and identifying marks used throughout this publication are the property of their respective trademark owners. They are used for descriptive purposes only and are protected by the relevant laws of the countries in which the trademarks are registered.





FRONT END LOADER BUCKETS



WA1200

Purpose : Bradken has a full range of Avalanche™ Front End Loader (FEL) Buckets built for durability and performance in all conditions for excavating, rehandling and stockpiling.

OEM : Avalanche FEL Buckets are engineered to suit OEM connections without the need for modification.

Size : Buckets range in size from 6m³ to >30m³ (7.8yd³ to >39.2yd³) capacities, while our customised range offers buckets to suit site specific production and maintenance requirements.

Tailored for : All Bradken Avalanche buckets, wear packages and GET can be tailored for use in General Purpose or Mining Class XHD (Extra Heavy Duty) applications.

Features	Advantage	Benefits
Wide and low design profile	Reduced fill times Quick clean dumping	Increased production
Optional cast alloy corners/transition plate	Additional strength in high stress and wear areas	Increased bucket life Reduced maintenance costs
Tyre deflectors	Guides material around expensive tyres	Reduced tyre consumable costs Increased production Increased machine availability
Compatible hook up points	Easy installation	Reduced machine downtime



Bradken's Twistlok™ is a Mining and Construction sized GET system offering a comprehensive range of point designs to suit every application. The Bradken Twistlok system features a positive locking point to adapter nose relationship, maximising fit surface contact to ensure even distribution of digging forces throughout the system.

Bradken believes the Twistlok system offers superior performance in the most extreme conditions, with the locking pin's unique metal and bonded rubber allowing for maximum positive retention throughout point life.

Changing systems is unnecessary because the Twistlok point simply fits to your current adapter system with a helix style nose using the Bradken locking pin.

Bradken can also design site specific points to suit your digging conditions.



Key	■ Construction
	■ Construction and Mining
	■ Mining



Features	Advantages	Benefits
Single piece locking pin	Reusable and reliable Fast installation	Increased machine production
Point retention	Minimal point movement that reduces fit wear	Reduced maintenance Reduced downtime costs
Bradken superior materials	Wear resistance and strength properties	Reduced downtime costs
Variety of point designs	Suits all digging conditions	Increased machine production Operational flexibility
Adapter wear cap	Increased adapter wear life	Reduced maintenance Reduced downtime costs Increased machine availability

BRADKEN ADAPTABILITY

Bradken's Twistlok system is able to be placed immediately on any adapter with a helix style nose using our unique locking pin.



BRADKEN ASSEMBLY

The additional benefits of using a full Bradken Twistlok system is the added wear cap feature, which provides your adapter with additional protection, while providing you with a full range of point designs.

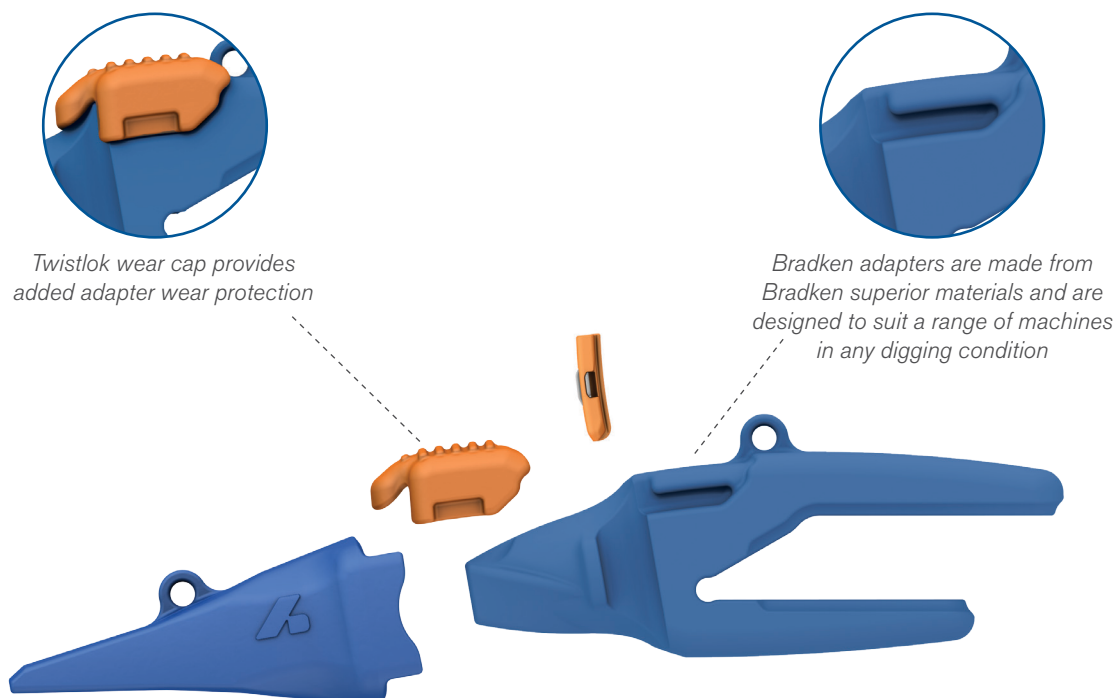



Twistlok^{pro} is the next evolution in Bradken's Plate Lip GET system for mining class excavators, rope shovels and front end loaders. Combined with Bradken's design expertise in lip design, Twistlok^{pro} provides you with benefits including:

- Fast and safe installation with hammer free installation of the point and locking pin.
- Prolonged adapter life with the inclusion (optional) of common wear caps on both the top and bottom leg, including straddle leg adapters.
- Increased point life from improved point styles.
- Safe removal of adapters with lifting points that are protected from material wash and damage.
- Interchangeable with existing Twistlok adapters and competitor's with a helix style nose.



TWISLOK ASSEMBLY

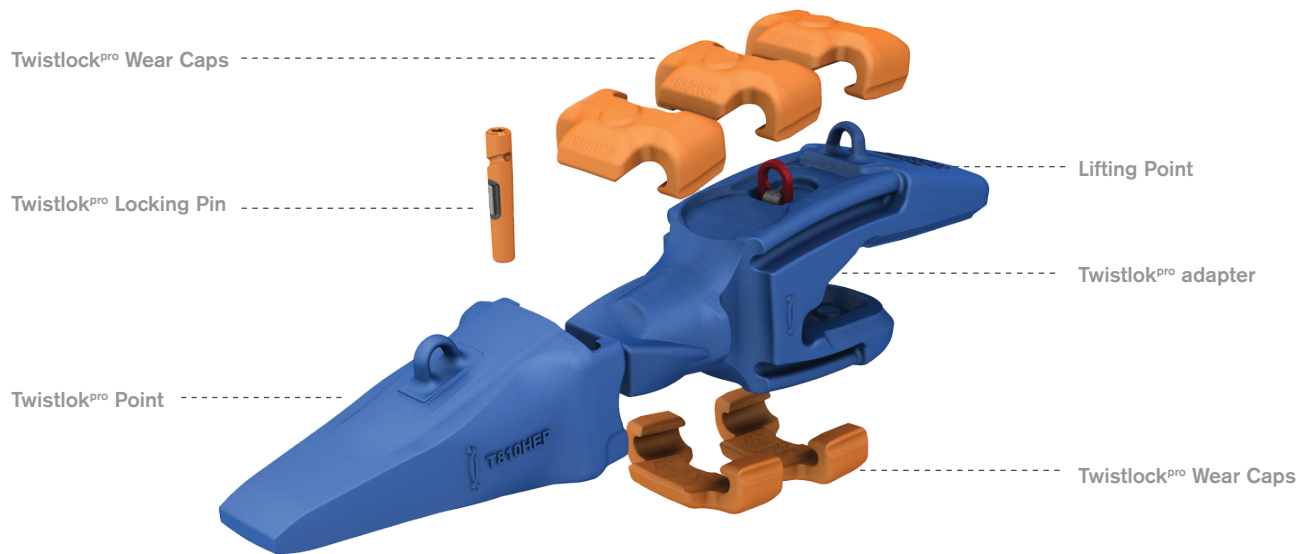

PROTECTED LIFTING POINT

Our T810 adapter range features a protected lifting point (Australian Standard certified) beneath the top leg wear caps, providing a safe and time effective means of removing the adapter from your machine.

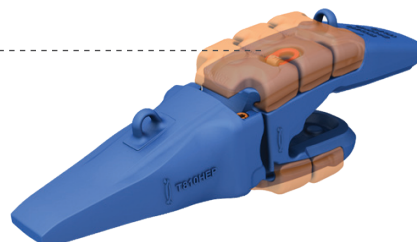



HAMMER FREE LOCKING PIN

Bradken's hammer free Twistlok^{PRO} locking pin provides improved safety, with a 17mm AF in-hex socket and a 3/4 drive breaker bar to install and remove the pin. The pin can be reused reducing the ongoing running costs of your machine.

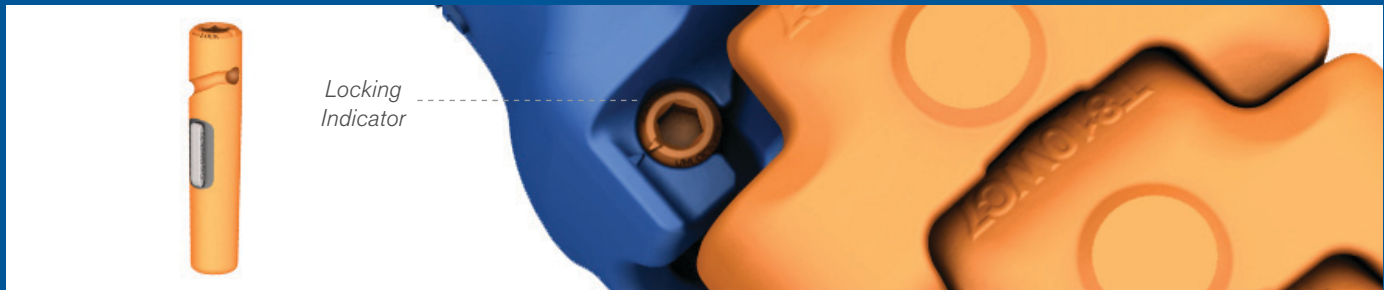

WEAR CAPS

A common Twistlok^{PRO} wear cap is available on both the top and bottom legs of mining sized adapters. Being a common wear cap, they can be interchanged across any of the five locations, which maximises the life of the wear cap. The addition of wear caps also eliminates the need for additional weld on protection to the adapter legs. Front End Loaders will benefit the most from bottom leg wear caps.



Wear caps protect both top and bottom adapter legs from wear.



Only the top leg is protected with a wear cap.

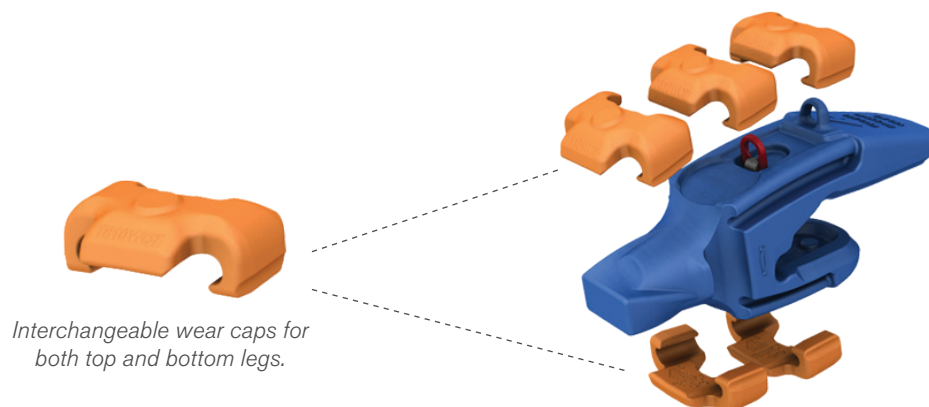

Interchangeable wear caps for both top and bottom legs.

POINTS

Points have been reengineered based on data collected from point wear and point performance of existing styles. Twistlok^{pro} points now feature an additional 10% to 15% wear material in critical wear areas, prolonging your point life.

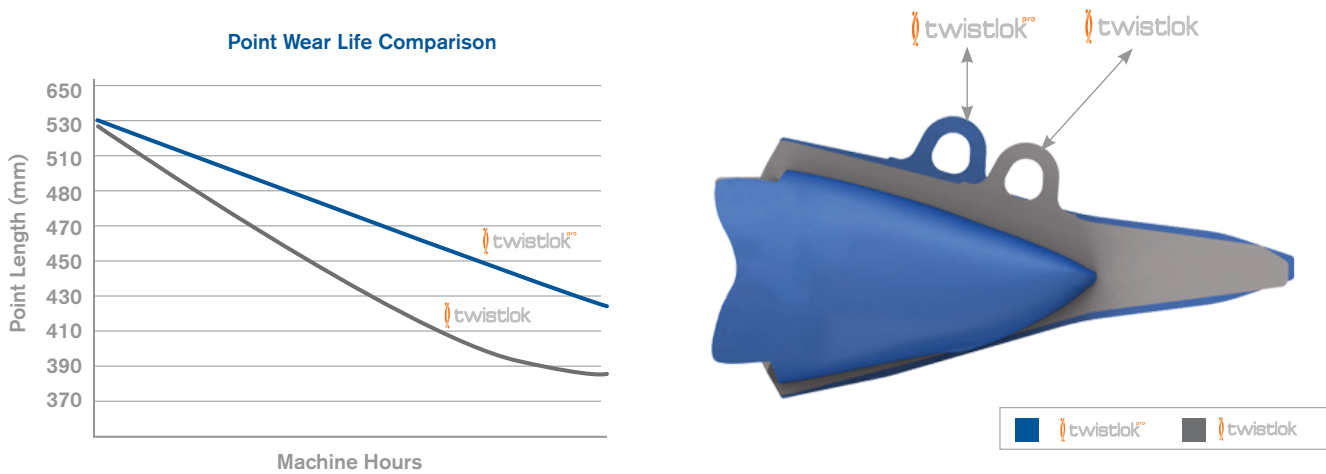

POINT STYLES

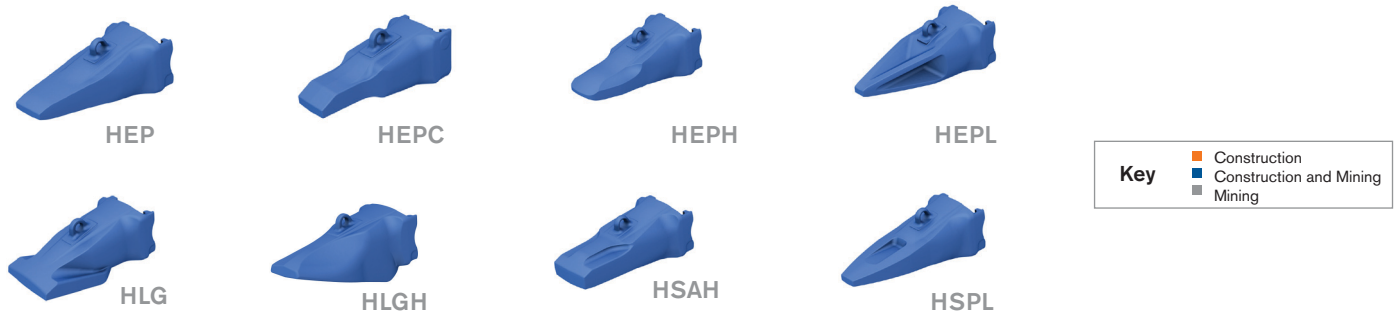

INTERCHANGEABLE

Twistlok^{pro} points are Interchangeable with existing Twistlok adapters and competitor's adapters with a helix style nose

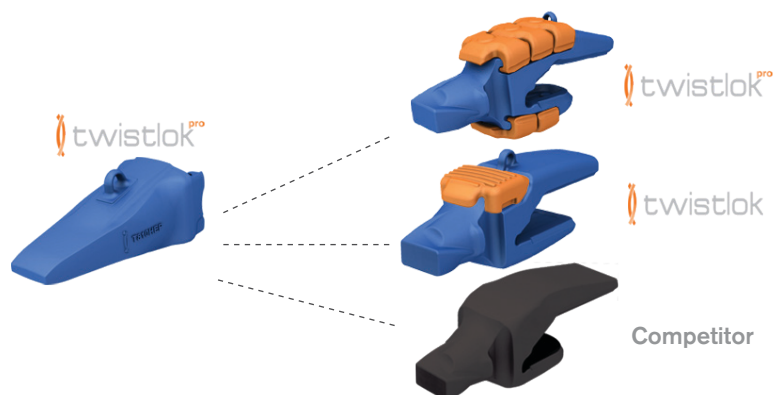



Bradken's Penetrator™ is a complete lip system featuring a cast lip, adapter and point or cast lip and solid point. Designed to meet the world's toughest digging conditions for Dragline, Face Shovel, Hoe Excavator and Dredging applications, the Penetrator adapter offers safety as a priority, incorporating hammerless adapter retention that can be retrofitted to cast lip noses.

The Penetrator point is engineered to fit onto the Penetrator adapter and can replace a number of GET offerings as a Direct Replacement Part (DRP) with Bradken's extensive range of point designs.

Changing systems is unnecessary, simply fit the Penetrator adapter and/or Penetrator point using the Bradken locking pin.

Features	Advantages	Benefits
Retractable adapter locking pin	Reusable hammerless design No need to remove lip shrouds Easy installation	Safety Reduced downtime Reduced inventory costs
Adapter with take up	Adjustable to maintain sound fit relationship	Reduced nose wear Reduced maintenance Less downtime
Variety of point designs	Suits all digging conditions	Increased machine production

POINT STYLES

Bradken can also design site specific points to suit your digging conditions.



Key	Construction	Construction and Mining	Mining
	Orange	Blue	Grey



BRADKEN ADAPTABILITY

Bradken's Penetrator offering can fit directly onto a competitor's integral nose.



Bradken points come in a range of designs to suit a variety of digging conditions

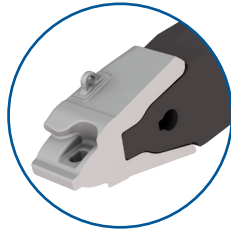

Bradken adapters provide excellent protection to the cast lip nose

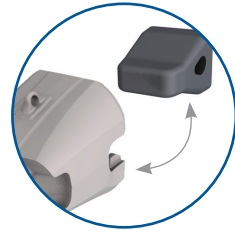

Bradken adapters fit on with ease

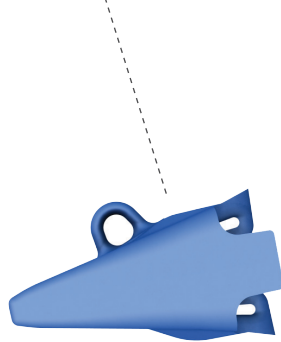

BRADKEN ASSEMBLY

By replacing your existing system with Bradken's Penetrator system you can be assured of quality and a system that will provide future innovative benefits for your mine site as enhanced options are released.



Bradken points come in a range of designs to suit a variety of digging conditions

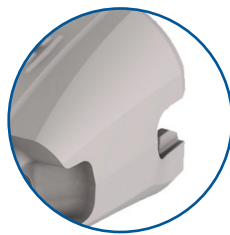

Bradken adapters have additional wear material around the locking mechanism for added protection

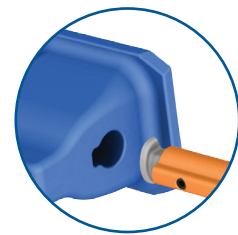

Bradken pins are hammerless to ensure safe operation on site

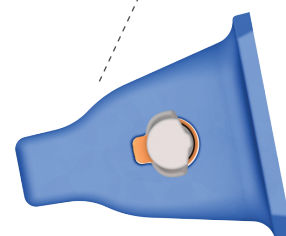
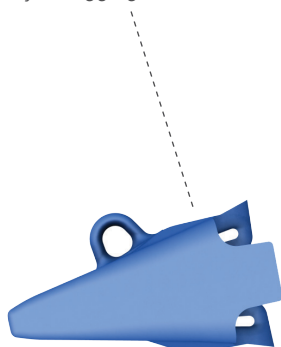



Bradken's Penetrator^{max} range is an evolution of our Penetrator product range. This system is designed to fit onto Bradken Penetrator and competitor cast lip noses, utilising a Bradken designed and manufactured adapter, point and hammer free locking pin system.

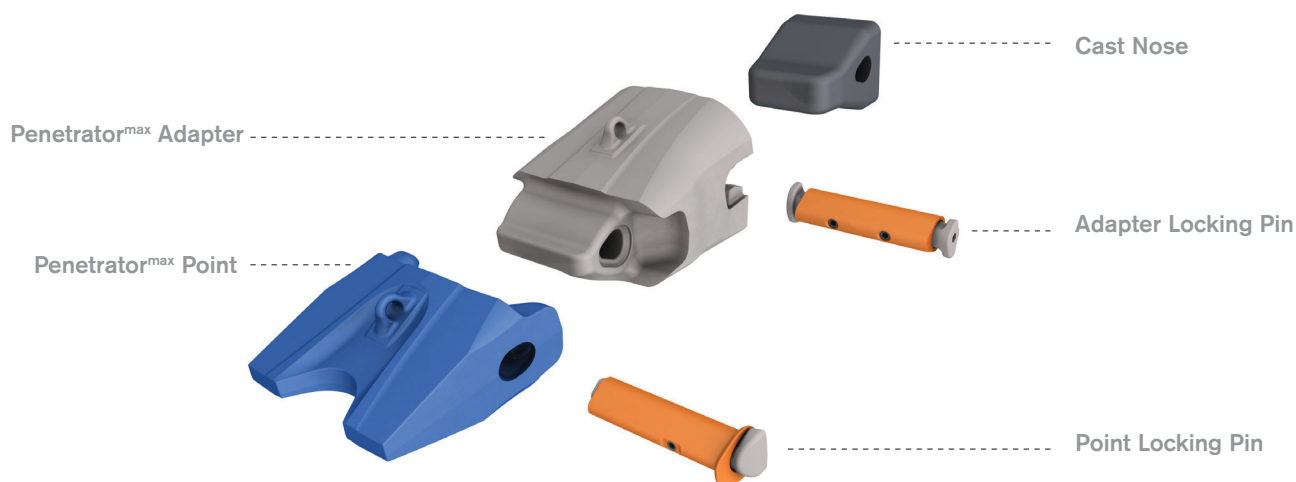

Bradken's range of hammer free points can be fitted to any other Bradken Penetrator^{max} adapter version (Bradken's Penetrator^{max} b-series, c-series and e-series), this in turn reduces the amount of inventory required on site.

Features	Advantages	Benefits
Adapters fit directly on to existing noses	Interchangeable GET across your bucket fleet No nose conversion or modification required	Maximise buying power Increased machine availability
Points have a common fit across all adapter series	Rationalise stock of high volume points Common installation/removal procedures	Reduced working capital Simplified purchasing Reduced training for maintenance teams
Horizontal locking pins in the points	15% increase in material use Pins remain in the adapter Pins are protected from wear and impact Re-usable locking pins	Reduced point change-out for higher machine availability Reduced risk of injury Reduce GET expenditure
Locking pin with take up in the mid-adapter and the point	Double sided adapter take up for even wear across the nose Reduced damage to adapter-point fit to maximise component life	Reduced nose repairs Reduce GET expenditure
Hammer free locking pins	No hammers or pin removal tools required to operate locking pins	Reduced risk of injury
Heavy Duty point options	Provides additional wear material to prolong component life	Improved planned maintenance Improved machine availability Reduced need for hardfacing



PA30P22M 57530
BA306-M
220KG



PP22GP



BA290
82KG
1844

PENETRATOR^{MAX} POINT STYLES

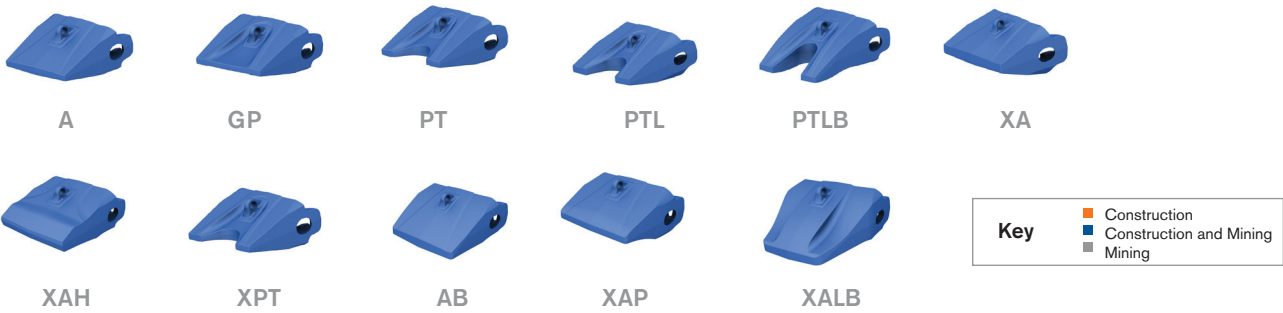

PENETRATOR^{MAX} ADAPTERS

Bradken's range of Penetrator^{max} adapters fit onto existing Bradken and competitor cast lip noses without the need for modification. Adapters are available in a standard or heavy duty options and irrespective of choice, if a standard size is selected, (i.e. 12 or 22) a common point can be fitted, thus reducing your inventory levels at your mine site.

b-series

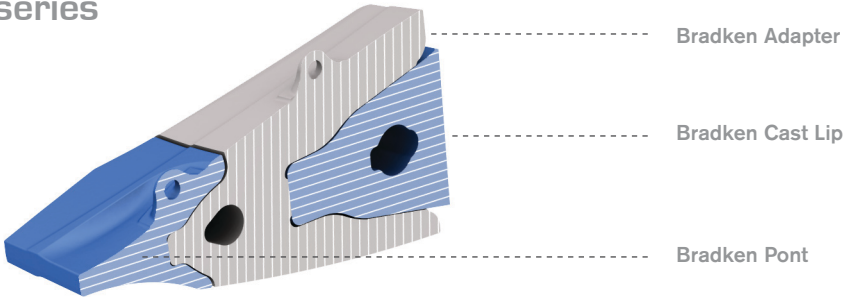

c-series

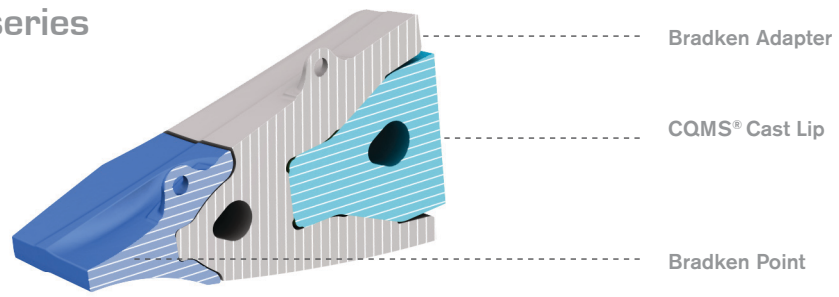

e-series

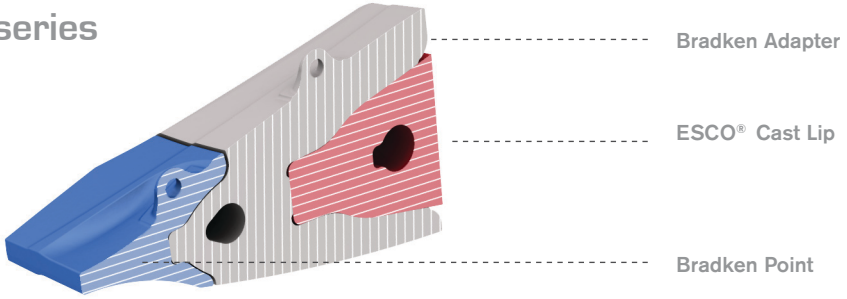



CAST LIP

Bradken's Penetrator cast lip and Ground Engaging Tool (GET) system can lower the TCO for your cast lip machine fleet. Bradken's Penetrator cast lips can be installed into Bradken's range of Avalanche mining buckets or can be custom manufactured to suit your existing OEM bucket fleet.

Fit a Penetrator cast lip to your bucket today for:

- Safer and faster GET installation and removal
- Fast filling, optimal bucket payloads
- Reduced maintenance costs and greater machine availability
- Interchangeability of GET across your bucket fleet
- Proven performance in hard rock and coal mining

DESIGN FEATURES

- Manufactured from Bradken's range of strong, weldable alloys
- Easily withstand maximum induced loading from all possible dig modes based on data collected from site visits, bucket repairs in our workshops and computer simulations
- Address problematic maintenance areas (e.g. wash areas beside the noses, cracking in weld stop/start locations)
- Minimise profile for optimal material flow into the bucket
- Design to fit existing buckets as well as new Bradken Avalanche bucket designs



DIGGING CONDITIONS

Lip Series	Coal Overburden	Copper	Gold	Iron Ore
30	✓	✓	✓	✓
45	✓	✓	✓	✓

PENETRATOR CAST LIPS AVAILABLE IN 30 & 45 SERIES

30 Series 5 Station Penetrator Cast Lip	30 Series 6 Station Penetrator Cast Lip	45 Series 6 Station Penetrator Cast Lip
PCL30-3759 (148in)	PCL30-4293 (169in)	PCL45-4293 (169in)
PCL30-4140 (163in)	PCL30-5105 (201in)	PCL45-5105 (201in)

CURRENT MACHINE FITMENTS OF PENETRATOR CAST LIPS

Lip Series	Machine Platform	Hydraulic Face Shovels	Hydraulic Excavators
30	RH200	✓	
30	RH340	✓	✓
30	CAT6060	✓	✓
30	PC5500		✓
30	EX5500	✓	✓
30	EX5600		✓
30	R996		✓
45	R996	✓	✓
45	R9800		✓
45	EX8000	✓	✓

PENETRATOR CAST LIP CONVERSIONS

Bradken can standardise your bucket fleet with Penetrator cast lips and G.E.T. (Ground Engaging Tools). Please contact your local Bradken representative for more information on how major mining houses have improved machine availability and reduced G.E.T. expenditure with Bradken's Penetrator product range.



DESIGNED FOR PRODUCT DURABILITY

Bradken's Penetrator cast lip is designed with the harshest digging conditions in mind. Bradken has used extensive Finite Element Analysis (FEA) to ensure the end result will meet the needs and requirements of mine sites around the world. The high strength, single beam design ensures maximum lip service life while the underside lip shroud recess and raised Defender lip shroud profile increases the shroud life and production, whilst reducing ongoing maintenance costs.

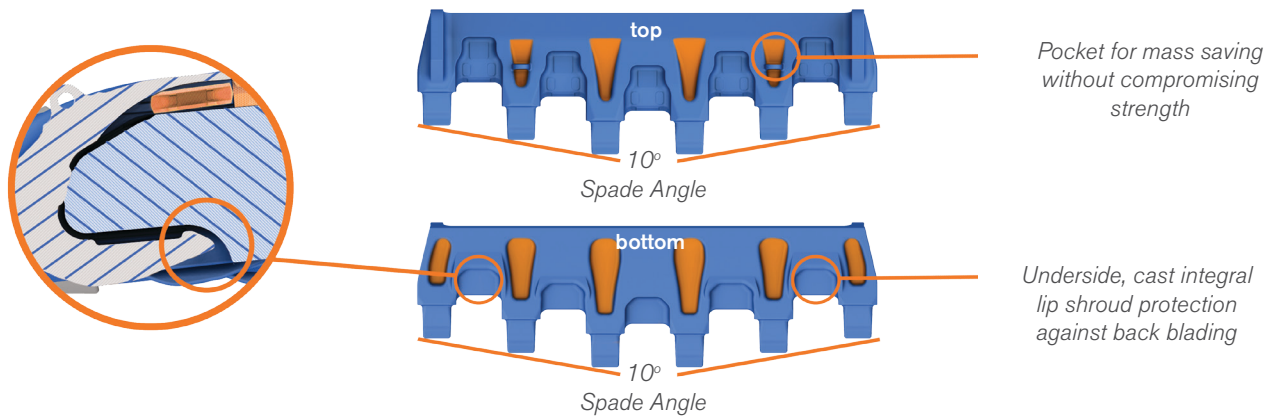

PENETRATOR LIP PROFILE

The Penetrator cast lip profile ensures material flow is optimised with inline shrouds, which in turn also enables improved penetration.

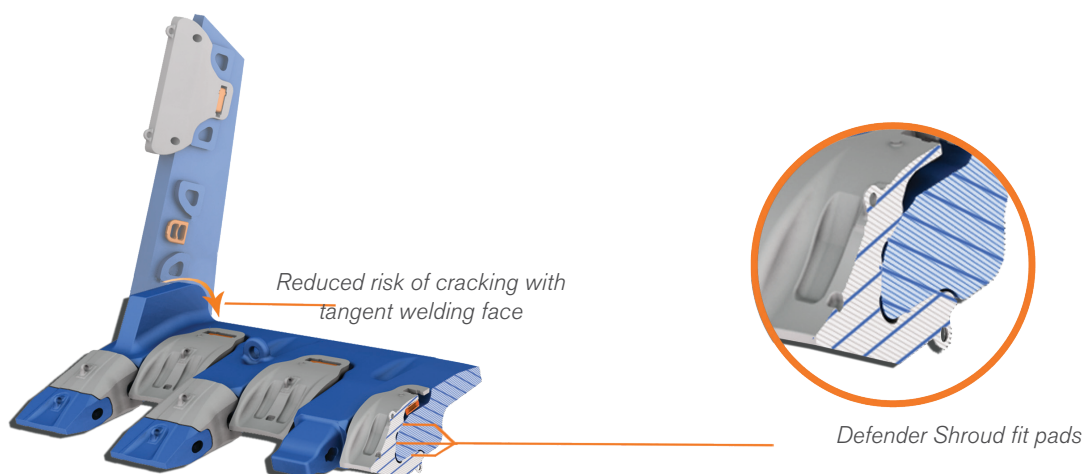
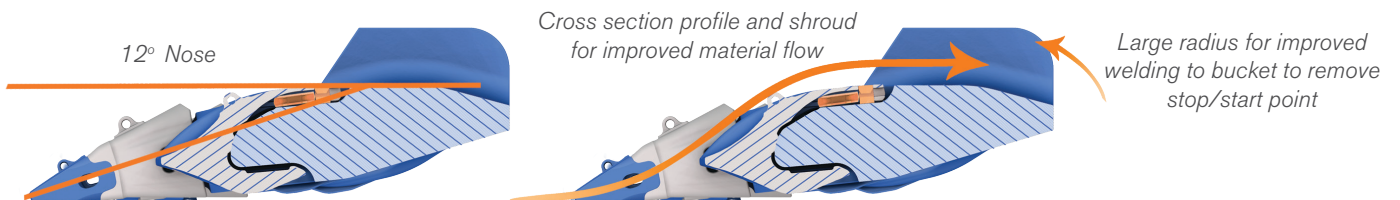



Bradken's range of Defender™ cast lip shrouds are designed to meet the worlds toughest digging conditions. The shrouds can be retrofitted onto existing profile bosses on competitor products and are manufactured in Bradken's superior alloys to provide improved wear life and reduced operating costs.

The Defender cast lip shroud for the Bradken Penetrator lip has the following features:

- Made from superior cast alloys
- Optimised external profile to improve penetration and lip protection
- External and internal wear indicators to assist with maximising shroud wear life and shroud replacement
- Self sharpening cavities to assist with maintaining shroud sharpness during its service life

DEFENDER SHROUD ADVANTAGES

Bradken's innovative shroud design features:

- Raised wings for increased strength
- Self sharpening cavities for improved penetration
- Leading edge wear indicator eliminating early change outs



Bradken's Defender cast lip shrouds have a unique concave sidewall which provides maximum protection to the Penetrator cast lip. With an elevated leading edge profile, the Defender shroud also provides optimal penetration in all digging conditions.

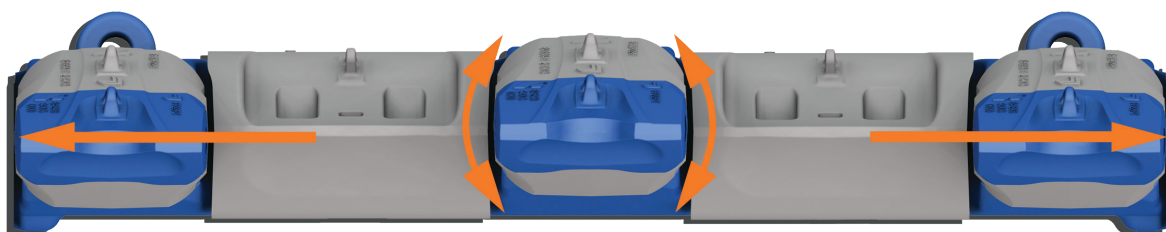

All shrouds and points are on the same plane for improved penetration

Shroud protecting wash over the side of the adapter, nose and lip.



PA80P12R 6137D
BA388-H
200KG

DEFENDER WING SHROUDS

Bradken's Defender wing shrouds are designed to fit a wide array of mining excavators, face shovel, front end loaders and construction machines and come in sizes ranging from 40mm to 160mm (1.6inch to 5.5inch).

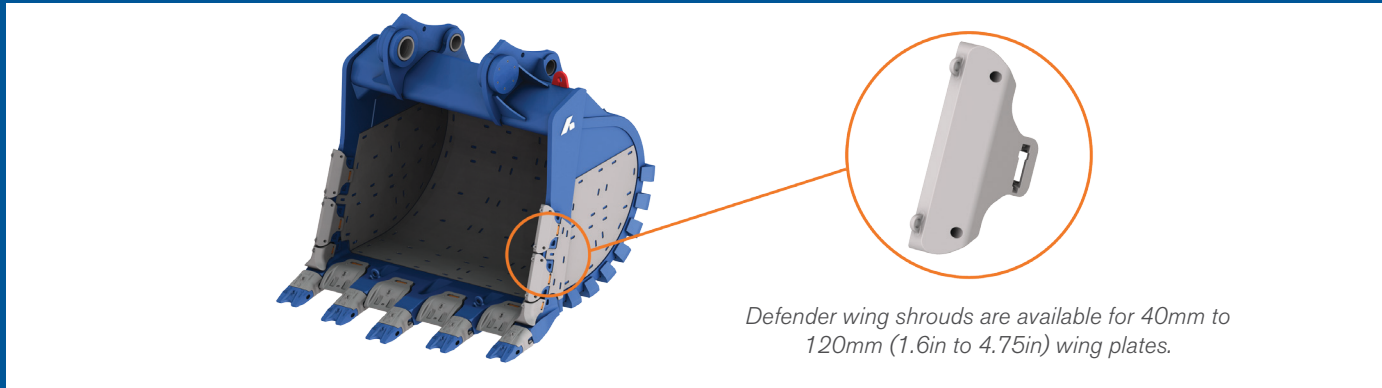
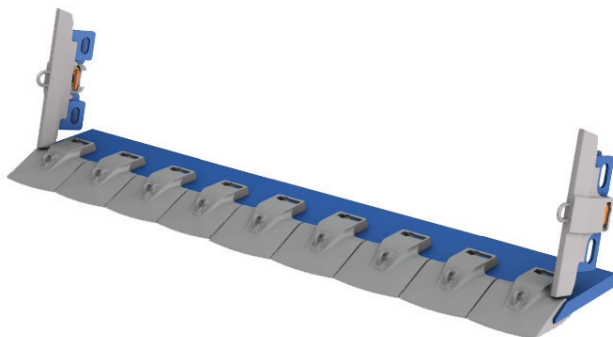

PLATE LIP

Bradken's plate lip are designed and manufactured to fit customers' existing OEM buckets as well as the new Bradken Avalanche bucket designs.

With the addition of a Bradken Twistlok^{PRO} (Ground Engaging Tool) system you can be assured of improved safety and efficiency, increased wearlife, and reduced maintenance downtime and associated costs.



Continuous Plate Lip System

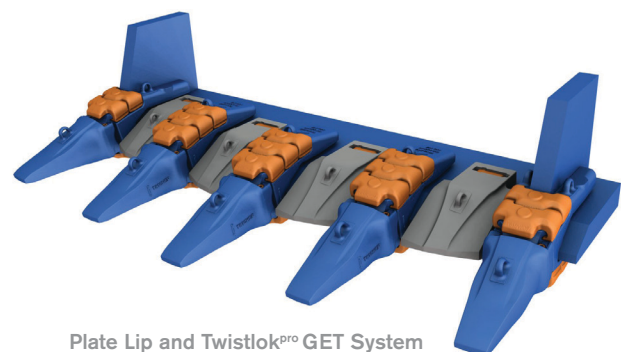

Plate Lip and Twistlok^{PRO} GET System

PLATE LIP PROFILE STYLES AND OPTIONS

Bradken offers a range of plate lip corner options (cast corners and straddles) and profile styles (straight, semi spade and full spade) for hydraulic excavators, front end loaders and electric face shovels.



Option 1: Straight Profile



Option 2: Semi Spade Profile



Option 3: Full Spade Profile

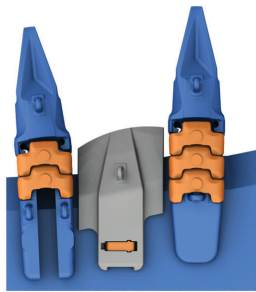

Option 1: Straddle

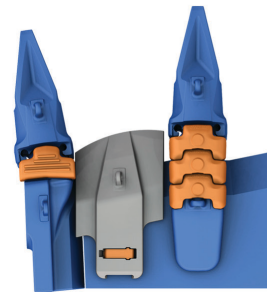

Option 2: Cast Corner

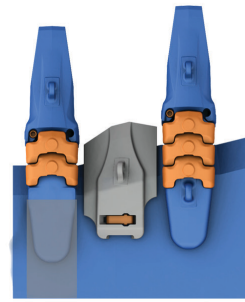

Option 3: Centreline with the Wing Plate

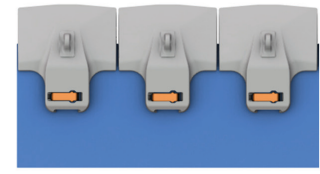

Option 4: Continuous Lip



Standard End



Cast Corner

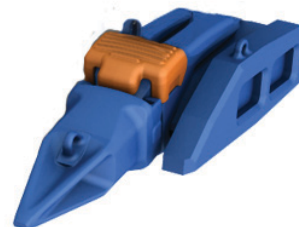

Lip End Protector

Aggressive Lip



Standard Lip

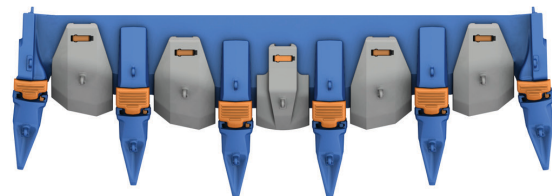

Bradken has expanded the Defender range to accommodate site specific lip designs, including the aggressive spade angles used for free digging applications.

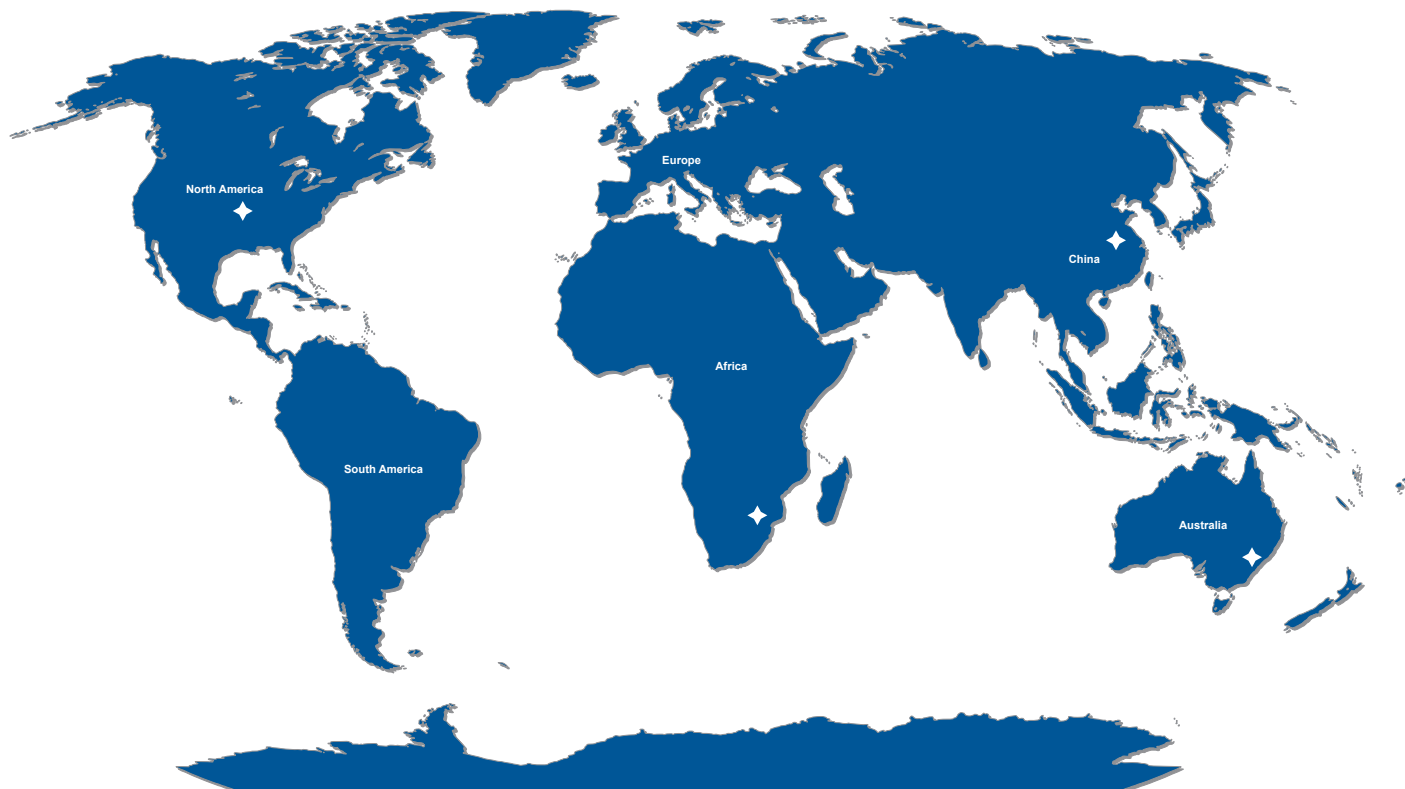

Global Corporate Centre

20 McIntosh Drive, Mayfield West, NSW 2304 Australia
T +61 2 4926 8200
F +61 2 4926 8201
E bradken@bradken.com

Visit bradken.com for your
local representative.

Regional Head Offices

AFRICA

Unit G1 The Palisades
39 Kelly Road
Jet Park South Africa
T +27 11 390 0100
F +27 86 615 0876
E africa@bradken.com

AMERICAS

Suite 647, 12200 NW Ambassador Drive
Kansas City MO 64163 USA
T +1 816 270 0700
F +1 816 270 0799
E americas@bradken.com

ASIA

No.120, XuHai Road South
Economic Development Zone
Xuzhou P.R. China 221131
T +86 516 8355 3958
F +86 516 8355 3959
E asia@bradken.com

PACIFIC

20 McIntosh Drive,
Mayfield West,
NSW 2304 Australia
T +61 2 4926 8200
F +61 2 4926 8201
E pacific@bradken.com

Our Innovation. Your Advantage.

