

ZAXIS-7 series

HITACHI

Reliable solutions

ZAXIS95W



WHEELED EXCAVATOR

Model code : ZX95W-7

Engine rated power : 55.4 kW (ISO 14396)

Operating weight : 9 200 – 9 970 kg

Bucket ISO heaped : 0.22 m³

You're in control

You're at the heart of Hitachi's design for its latest range of excavators. To continuously improve on previous generation machines we've focused on enhancing your experience in the cab as an operator.

We've considered the challenges you face as the owner of a successful business. And we've zoomed in on the ways in which we can support you over the life cycle of your machine.

By putting you at the heart of the Zaxis-7 range, we invite you to take control – over your workspace and your fleet. And by working in partnership, we will help you to create your vision.





Inside



In control of your business

8. Improve your profit



In control of your comfort

10. Feel the difference



In control of your environment

12. Increase your safety



In control of your assets

14. Boost your uptime



In control of your fleet

16. Manage your machine



In control of your uptime

18. Protect your investment



In control of your performance

20. Get more from your machine

Complete control

The new Zaxis-7 range of wheeled excavators puts you firmly in control, so you can feel assured of your machine's performance, and supported by the technological expertise and services that Hitachi provides.

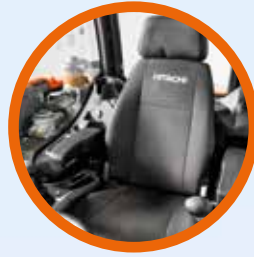

Ultra-spacious comfortable cab has air conditioning and air-suspension seat.



Options such as Hitachi buckets and ground engaging tools enable you to enhance the performance of your excavator.



Exceptional agility thanks to the choice of four-wheel or crab steering.



Easy operation comes from the intuitive controls, within easy reach.



Visibility of the job site is excellent thanks to the rear-view camera.



Easy access to components ensures maintenance is quick and convenient.



The short turning radius and swing boom are ideal for working on narrow job sites, enhancing versatility.



2

1

3

4

5

6

7

8

16

9

11

14

15

10

12

13

HITACHI

Control zone

Enhanced comfort and safety features are at your fingertips in the cab of the ZX95W-7, giving you the power to perform productively, with ease and reduced fatigue.

- ① **Front visibility** is excellent thanks to the adjustable steering column and small steering wheel.
- ② **Front windows** are easy to open.
- ③ **Colour monitor** is easy to view and navigate.
- ④ **Smartphone holder** helps you stay safe and connected.
- ⑤ **Adjustable joystick controls** for effortless operation.
- ⑥ **Blade and outrigger lever** provides fingertip control.
- ⑦ **Air conditioning** creates a comfortable working environment.
- ⑧ **Intuitive controls** within easy reach.
- ⑨ **USB socket** keeps your device fully charged.
- ⑩ **Bluetooth®** for hands-free calls and DAB+ radio for music while you work.
- ⑪ **Multifunctional control panel** makes operation easier.
- ⑫ **Drinks holder** can be removed for cleaning.
- ⑬ **User-friendly storage** keeps your workspace tidy and clutter-free.
- ⑭ **A coat hook** takes care of your personal belongings.
- ⑮ **Quick coupler switch** for easily changing attachments.
- ⑯ **Comfortable operation** from the heated air-suspension seat.



Operation is easy with ergonomically designed controls and switches.



Bluetooth® connection for hands-free calls while you work.

In control of your business



Improve your profit

The success of your business depends on the reliability and efficiency of your construction machinery. With Hitachi Zaxis-7 wheeled excavators, you can count on the highest quality, the ultimate in operating comfort and reduced running costs – all of which will have a positive impact on your bottom line.

You can increase profits by working on a wider range of projects thanks to the versatility of the ZX95W-7. Its compact size and short turning radius allow it to work efficiently and safely in confined areas. With the option to use biodegradable oil, the ZX95W-7 is also suitable for working in environmentally sensitive areas.

The two-piece boom, in combination with the swing boom, make it a perfect match for every job site. Versatility is further enhanced as the usage of hydraulic quick couplers and tiltrotators is fully supported with factory preparation available (optional for tiltrotators).

In addition, the ZX95W-7 is exceptionally agile thanks to the choice of four-wheel or crab steering. It also offers excellent lifting capacity – which can be further increased with an additional counterweight – to deliver even higher levels of productivity.



Exceptional manoeuvrability with four-wheel steering.



Work efficiently in small spaces thanks to the short turning radius and swing boom.



The exceptional versatility of the ZX95W-7 makes it suitable for a variety of projects and applications.



Two-piece boom enhances versatility.



Excellent lifting capacity boosts productivity.



Sit comfortably in the air-suspension seat.



Intuitive controls are within easy reach.



Joystick buttons can be adjusted to suit your preference.



In control of your comfort



Feel the difference

The cab of the ZX95W-7 is the perfect working environment. Ultra-spacious, it offers the ultimate in comfort and quality, with air conditioning, easily opened front windows, and air-suspension seat included as standard.

Feel the difference with intuitive controls, which are within easy reach. Buttons on the joysticks can be configured to your personal preference, and make your working day effortless and enjoyable. Easy operation comes from the colour monitor, which is easy to view and navigate.

With plenty of storage space for your personal belongings, such as your coat, smartphone and drink, you'll feel instantly relaxed and ready for your shift.



Easy operation using the small steering wheel.



Create your ideal workspace with the adjustable steering column.

In control of your environment



Increase your safety

Your ability to work safely is vital, not only for your own wellbeing, but also for the successful completion of any project. To protect yourself and your machine from potential hazards, the new Hitachi Zaxis-7 excavators give you a superior view of your surroundings, so you can see the job site from all angles.

The visibility you enjoy from the cab is boosted by the rear-view camera and the optional side view camera. This enables you to control your own safety – as well as that of those around you.

Visibility through the cab's front window is also enhanced by the small steering wheel. To help you to work more confidently, the ZX95W-7 has a blade positioned on the rear of the undercarriage, and (optional) independently operating outriggers for added stability.



Work safely thanks to the rear-view camera.



The independently operating outriggers enhance stability.



Control your safety with excellent visibility from the cab.



The cab interior is designed to allow a high level of visibility.



Additional visibility from the sunscreen.



Boom cylinder protection enhances durability.



Easy access to components simplifies maintenance.



The radiator compartment is easy to clean.



Designed for durability and easy maintenance, Zaxis-7 excavators increase uptime and reduce the total cost of ownership.



In control of your assets



Boost your uptime

Completing a project on time and on budget depends on the ability of your construction equipment to perform all day, every day. That's why Hitachi owners have profited from generations of ultra-reliable and durable machinery – and the Zaxis-7 range is no exception.

The ZX95W-7 has been built to last with durable components, so that you can remain in complete control of your assets. It has been tested rigorously and continuously at dedicated facilities with the goal of significantly boosting your uptime.

Downtime is minimised by the priority given to easy maintenance and cleaning – saving you time and money. The Stage V-compliant engine does not require an SCR system, which eliminates the need for urea and associated maintenance. The auto-lubrication system will also reduce downtime, as well as life-cycle costs.

In control of your fleet



Manage your machine

Hitachi offers a wide range of after-sales services to help you feel in total control of your fleet and workload. These initiatives give you access to vital data and tools to manage your machine.

Remote monitoring system Owner's Site sends operational data daily via GPRS or satellite from your ZX95W-7 to the Global e-Service website. This includes: ratios of operating hours to enhance efficiency; fuel consumption to manage running costs; and machine location for planning purposes.

In addition, the machine can only be started by entering a PIN on the control pad immobiliser. The PIN can easily be assigned to a specific user, for a certain time. This optional device is ideal for hire fleets, providing additional security and peace of mind.



Operational data is transmitted from your machine via GPRS or satellite.



A wide range of data on Global e-Service enhances efficiency.



Additional security comes from the control pad immobiliser.



Hitachi offers a wide range of after-sales services for planning maintenance and managing running costs.



Minimise downtime with Hitachi Genuine Parts.



HELP extended warranties and service contracts provide optimal performance.



Hitachi Premium Rental enables you to pay as you earn.



Hitachi provides the highest level of technical support.



In control of your uptime



Protect your investment

If your machine will be working in severe conditions, or you want to minimise repair costs, you can take advantage of a unique extended warranty programme called HELP (Hitachi Extended Life Program) and comprehensive service contracts. These can help to optimise performance, reduce downtime and ensure a higher resale value.

We apply the same technological expertise to our wide range of high-quality parts as we do our machines. As a result, you can minimise unscheduled downtime and ensure maximum availability.

The parts range includes Hitachi Genuine Parts, Performance Parts, filters, undercarriages, and remanufactured components. We also offer ground engaging tools and buckets, which have been manufactured to the same exacting standards.

As your business grows, you may need to extend your fleet to meet the demands of new contracts. Why not try before you buy with the Hitachi Premium Rental programme? This gives you immediate access to Zaxis-7 excavators for a period of one month to a year.

Along with the reliability, quality and service you would expect from the Hitachi brand, Hitachi Premium Rental offers flexible contracts and fixed costs that make it easier for you to budget.

In control of your performance



GET more from your machine

Designed to work in perfect harmony with your machine, Hitachi buckets and ground engaging tools (GET) will increase your profit by maximising productivity and uptime. Manufactured to the same high standards as all Hitachi construction equipment, they offer unrivalled reliability and exceptional performance.

Buckets

You can increase the versatility of your excavator by choosing the right bucket for the job. For loading light materials or heavy-duty work, Hitachi buckets can be customised to meet your needs. You have a wide range of options to choose from – including digging buckets and ditch-cleaning buckets in GD and HD versions, with different capacities and widths – and quick coupler connections such as CW, pin grabber and S-coupling are also available.

Ground engaging tools

You can enhance the digging power and productivity of your compact wheeled excavator with Hitachi Select Parts high-quality ground engaging tools. Quick and safe to install and replace, they fit precisely to your attachments and can be tailored to suit the task. They can reduce your maintenance costs and downtime, lower fuel consumption and enhance the overall performance of your machine.

Tiltrotator

Your ZX95W-7 can be prepared for tiltrotator installation as a factory option. This will further enhance the versatility and efficiency of your wheeled excavator.



Hitachi buckets are manufactured to the same high standards as all Hitachi construction equipment.



Hitachi buckets can be customised to suit the application.



For added convenience and versatility, the blade is prepared for trailer hook installation.



High-quality ground engaging tools include self-sharpening teeth and reliable adapters to ensure a precise fit.



EH dump trucks and EX ultra-large excavators



Special application excavators



Create your vision

In control of your world

When you take delivery of a Hitachi machine, you become part of the latest generation of a global family. With a 50-year heritage in designing hydraulic excavators, and a reputation as the industry's leading mining machine manufacturer, the Hitachi network will give you access to a range of exceptional construction equipment.

Like the new Zaxis-7 excavators, Hitachi wheel loaders, rigid dump trucks, and special application machines incorporate advanced technology and pioneering expertise.

In addition to the latest products made at state-of-the-art facilities and built to the highest quality standards, you'll have the support of our experienced engineers and dedicated dealer personnel. You'll also benefit from market-leading services and initiatives, such as Premium Rental and Premium Used, which have been created to enhance your experience as a Hitachi customer.

Whatever vision you wish to create, Hitachi has the product, people, solutions and services you need to make it become a reality – and empower you to take control of your world.



ZW wheel loaders



Mini excavators

SPECIFICATIONS

ENGINE

ZX95W-7

Model	DEUTZ TCD 2.9 L4 Stage 5
Type	4-cycle water cooled, common rail direct injection
Aspiration	Turbocharged with waste gate, intercooled, cooled EGR
Aftertreatment	DOC + DPF
No. of cylinders	4
Rated power	
DIN 70020/ECE-R2403	55.4 kW at 2 300 rpm
Maximum torque	
DIN 70020/ECE-R2403	300 Nm at 1 600 rpm
Piston displacement	2.9 L
Bore and stroke	92 mm x 110 mm
Battery	1x 12V / 120 Ah

HYDRAULIC SYSTEM

Hydraulic Pumps

Main pumps	2 variable displacement axial pistons pumps (tandem type)
Maximum oil flow (Transmission)	1 x 145 L/min
Maximum oil flow (Attachment)	1 x 117 L/min
Double pump	
Maximum oil flow (Pilot)	11 cm ³
Maximum oil flow (Steering)	14 cm ³

Hydraulic Motor

Travel	1 variable displacement axial piston motor
Swing	1 axial radial piston motor

Relief Valve Setting

	ZX95W-7
Implement circuit	28 MPa
Swing circuit	24 MPa
Travel circuit	40 MPa
Pilot circuit	3.7 MPa

Hydraulic Cylinders

	Quantity	Bore Ø	Rod Ø
Swing cylinder	1	110	63
Lift cylinder	1	115	70
Positioning boom cylinders	2	100	50
Dipperstick cylinder	1	100	63
Bucket cylinder	1	90	56
Blade cylinder	1	100	50
Outriggers cylinders	2	63	35

Unit: mm

SPECIFICATIONS

ZX95W-7

WORKING RANGES

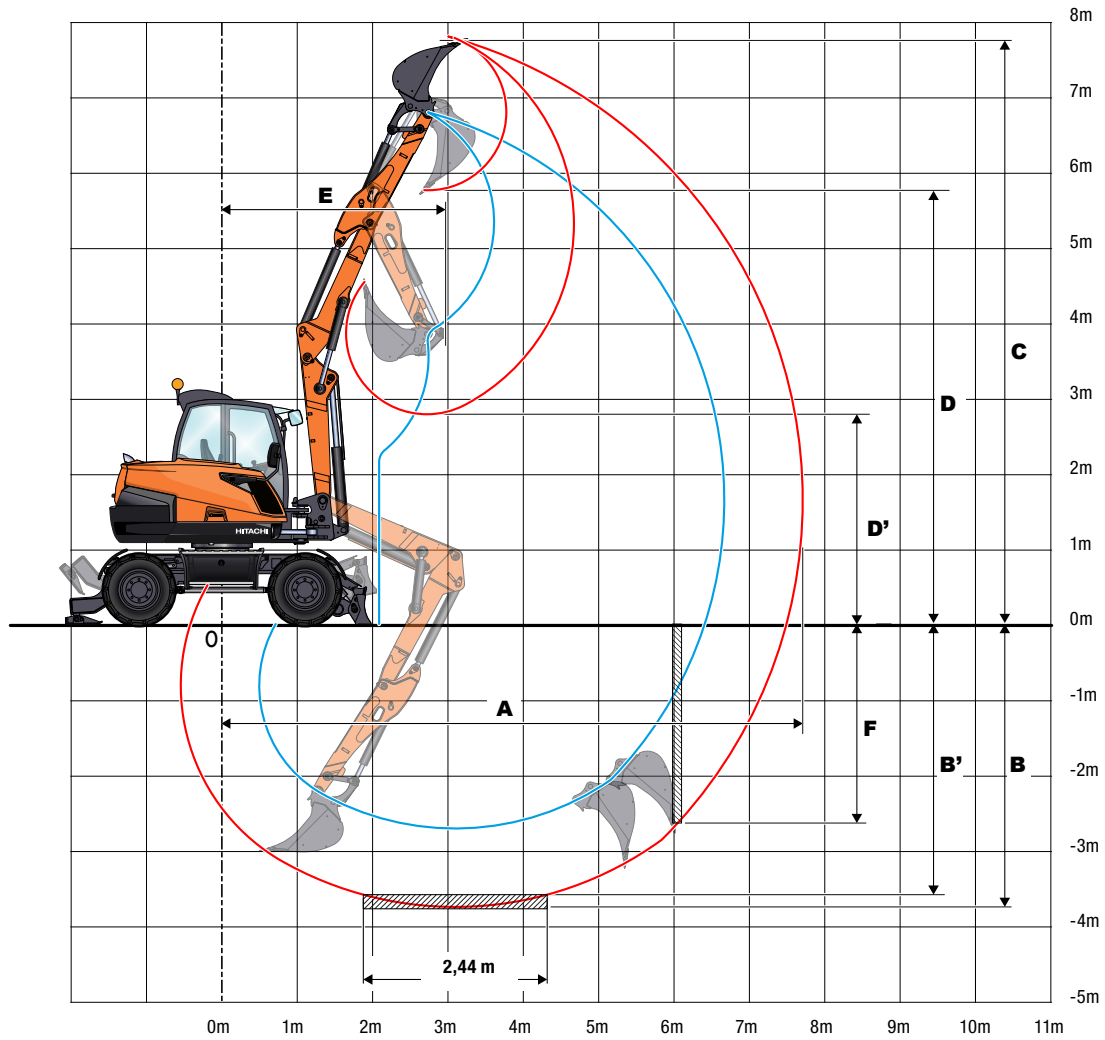

Unit: mm

A Max. digging reach	7 701
B Max. digging depth	3 754
B' Max. digging depth for 2.44 m level	3 591
C Max. cutting height	7 746
D Max. dumping height	5 786
D' Min. dumping height	2 819
E Min. swing radius	2 896
F Max. vertical wall digging depth	2 641

SPECIFICATIONS

ZX95W-7

DIMENSIONS

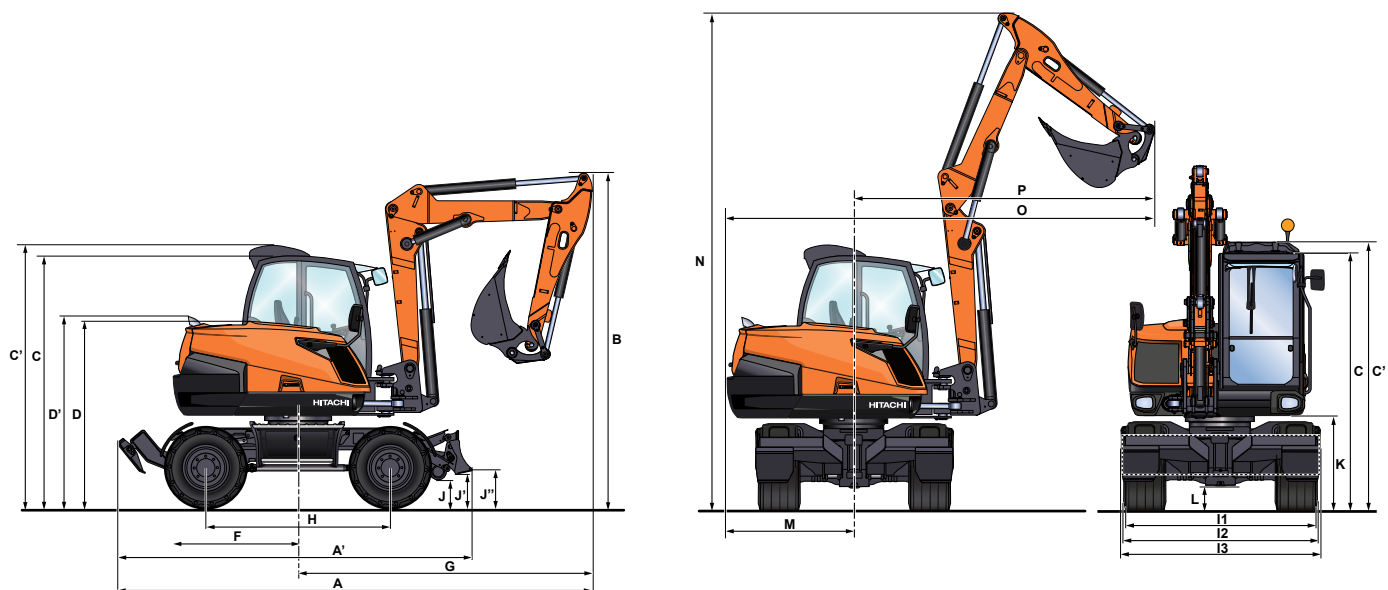

Unit: mm

A	Overall length	5 665
A'	Overall length undercarriage (without upper carriage)	4 235
B	Overall height	3 986
B'	Overall height (with hose)	3 986
C	Machine height (without attachment and without AC)	2 977
C'	Machine height (without attachment, with AC)	3 109
D	Cover height (without exhaust)	2 181
D'	Cover height (with exhaust)	2 268
E	Ground clearance	528
F	Rear overhang	1 487
G	Front overhang	3 509
H	Wheelbase	2 200
I1	Blade width	2 300
I2	Outrigger width	2 311
I3	Width with twin wheels 8.25-20 BKT	2 330
J	Height with blade raised	321
J'	Height with blade raised	391
J''	Height with blade raised	429
K	Height under upper carriage	1 082
L	Ground clearance	310
M	Counterweight radius (equal to rear overhang)	1 487
N	Folded position height	5 876
O	Minimum upper carriage overall dimensions	4 383
P	Minimum front radius	2 896
	Lifting Boom length	1 910
	Positioning Boom	1 970
	Dipperstick length	1 650











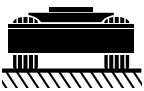

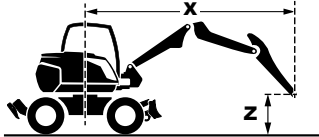
SPECIFICATIONS











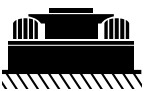

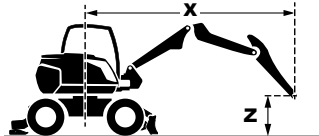
ZX95W-7

LIFT CAPACITIES

According to ISO 10567: 75% of the tipping load or 87% of the hydraulic limit.

ZX95W-7 FRONT BLADE AND REAR OUTRIGGERS

BLADE AND OUTRIGGERS RAISED									
	 Working in longitudinal position			 MAX kg					
	 Working in transverse position								
Z \ X	3 m		4 m		5 m		6 m		
									
5 m	-	-	2 300	1 800	1 600	1 150	-	-	
3 m	3 600	2 500	2 300	1 700	1 600	1 150	1 150	850	
1.5 m	3 500	2 500	2 300	1 600	1 600	1 150	1 150	850	
0 m	3 200	2 200	2 100	1 450	1 500	1 000	1 100	800	
-1 m	3 200	2 200	2 100	1 400	1 500	1 000	1 100	800	
-2 m	3 300	2 200	2 100	1 400	1 400	1 000	-	-	
-2.5 m	3 300	2 200	1 800	1 400	-	-	-	-	









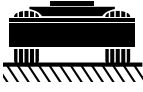

BLADE AND OUTRIGGERS LOWERED									
	 Working in longitudinal position			 MAX kg					
	 Working in transverse position								
Z \ X	3 m		4 m		5 m		6 m		
									
5 m	-	-	2 300	2 300	2 000	1 800	-	-	
3 m	3 800	3 700	2 900	2 400	2 200	1 750	1 900	1 200	
1.5 m	4 950	3 700	3 450	2 400	2 500	1 650	1 900	1 200	
0 m	5 800	3 500	3 500	2 200	2 550	1 600	1 900	1 200	
-1 m	5 900	3 500	3 650	2 200	2 450	1 550	1 400	1 200	
-2 m	5 000	3 500	2 850	2 200	1 400	1 400	-	-	
-2.5 m	3 500	3 500	1 800	1 800	-	-	-	-	

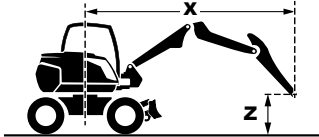







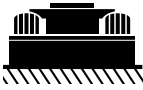

SPECIFICATIONS

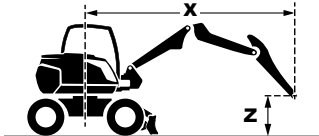
ZX95W-7

LIFT CAPACITIES

ZX95W-7 REAR BLADE

BLADE RAISED								
	Working in longitudinal position							
	Working in transverse position							
Z \ X	3 m		4 m		5 m		6 m	
								
5 m	-	-	2 100	1 700	1 400	1 150	-	-
3 m	3 200	2 500	2 050	1 650	1 400	1 150	1 000	800
1.5 m	3 000	2 250	1 950	1 550	1 400	1 050	950	750
0 m	2 750	2 050	1 800	1 350	1 250	1 000	900	700
-1 m	2 750	2 050	1 750	1 350	1 200	950	900	700
-2 m	2 750	2 050	1 750	1 350	1 200	950	-	-
-2.5 m	2 750	2 050	1 750	1 350	-	-	-	-

BLADE LOWERED								
	Working in longitudinal position on blade side							
	Working in transverse position							
Z \ X	3 m		4 m		5 m		6 m	
								
5 m	-	-	2 300	1 950	2 000	1 300	-	-
3 m	3 800	2 900	2 900	1 900	2 200	1 300	1 900	900
1.5 m	4 950	2 700	3 450	1 800	2 500	1 250	1 900	850
0 m	5 800	2 400	3 500	1 600	2 550	1 150	1 900	800
-1 m	5 900	2 400	3 650	1 600	2 450	1 100	1 400	800
-2 m	5 000	2 400	2 850	1 600	1 400	1 100	-	-
-2.5 m	3 500	2 400	1 800	1 600	-	-	-	-

ZX95W-7 REAR BLADE AND 420 KG COUNTERWEIGHT

BLADE RAISED								
Z \ X	3 m		4 m		5 m		6 m	
	0°	90°	0°	90°	0°	90°	0°	90°
5,0	-	-	2 300	1 800	1 600	1 150	-	-
3,0	3 600	2 500	2 300	1 700	1 600	1 150	1 150	850
1,5	3 500	2 500	2 300	1 600	1 600	1 150	1 150	850
0	3 200	2 200	2 100	1 450	1 500	1 000	1 100	800
-1	3 200	2 200	2 100	1 400	1 500	1 000	1 100	800
-2	3 300	2 200	2 100	1 400	1 400	1 000	-	-
-2,5	3 300	2 200	1 800	1 400	-	-	-	-

BLADE LOWERED								
Z \ X	3 m		4 m		5 m		6 m	
	0°	90°	0°	90°	0°	90°	0°	90°
5,0	-	-	2 300	2 050	2 000	1 400	-	-
3,0	3 800	3 050	2 900	1 950	2 200	1 400	1 900	950
1,5	4 950	2 850	3 450	1 850	2 500	1 300	1 900	950
0	5 800	2 600	3 500	1 700	2 550	1 200	1 900	900
-1	5 900	2 600	3 650	1 700	2 450	1 200	1 400	850
-2	5 000	2 600	2 850	1 700	1 400	1 200	-	-
-2,5	3 500	2 600	1 800	1 700	-	-	-	-

EQUIPMENT

ZX95W-7

ENGINE	ZX95W-7
Aftertreatment device	●
Air cleaner double filters	●
Alternator 120 A	●
Auto idle system	●
Auto shut-down control	●
Cartridge-type engine oil filter	●
Cartridge-type fuel main filter	●
Dry-type air filter with evacuator valve (with air filter restriction indicator)	●
ECO/PWR mode control	●
Electrical fuel feed pump	●
Expansion tank	●
Fan guard	●
Fuel pre-filter with water separator	●
Radiator, oil cooler and intercooler	●

HYDRAULIC SYSTEM	
Auto power lift	●
Control valve with main relief valve	●
Extra port for control valve	●
Hose rupture valve for arm	●
Hose rupture valve for boom	●
Hose rupture valve for bucket	●
Hydraulic oil, biodegradable	○
LUDV (load sensing flow sharing system)	●
Shockless valve in pilot circuit	●
Suction filter	●
Swing dampener valve	●
Variable reliefvalve for breaker and crusher	●
Work mode selector	●

CAB	ZX95W-7
All-weather sound suppressed steel cab	●
Air conditioner	●
AUX function lever (breaker assist)	●
Bluetooth®* integrated DAB+radio and handsfree call system	●
Control lever auto-lock	●
Drink holder	●
Electric horn	●
Engine start-stop button	●
Equipped with reinforced, tinted (green color) glass windows	●
Floor mat	●
Front window washer	●
Intermittent windshield wiper	●
Parallel front window wiper	●
Pilot shut-off lever	●
Power outlet 12 V	●
Rain guard	●
Rear tray	●
Retractable seat belt	●
Room light	●
ROPS (ISO12117-2 : 2008) compliant cab	●
Rubber radio antenna	●
Seat : air suspension seat with heater	●
Seat adjustment part : backrest, armrest, height and angle, slide forward / back	●
Short wrist control levers with configurable buttons	●
Smartphone holder	●
Sunscreen roller type (front window)	●
Transparent roof with sunscreen roller type	●
Windows on front, upper, lower and left side can be opened	●
2 speakers	●
5 V to USB power supply	●
7" Colour monitor	●

MONITOR SYSTEM	ZX95W-7
Alarm buzzers: overheat, engine oil pressure, overload, SCR system trouble, etc.	●
Alarms: overheat, engine warning, engine oil pressure, alternator, minimum fuel level, hydraulic filter restriction, air filter restriction, overload, SCR system trouble, etc.	●
Attachment operational information	●
Display of meters: Speedometer, Tachometer, water temperature, hour, fuel rate, clock, etc.	●
Other displays: Work mode, auto-idle, glow, rearview monitor, etc.	●

LIGHTS	
Additional cab roof front light	○
Additional cab roof rear light	○
Brake lamps	●
Cab roof front light	●
Hazard lamps	●
Headlight	●
Rotating LED lamp (cab)	○
Turn signal lamps	●

UPPERSTRUCTURE	
Rear view camera	●
Side view camera	○
Battery 1 x 120 Ah	●
Battery disconnect switch	●
Counterweight 1 375 kg	●
Electric fuel refilling pump with auto stop and filter	●
Fuel level float	●
Hydraulic oil level gauge	●
Lockable machine covers	●
Rear view mirror (right and left side)	●
Swing parking brake	●
Travelling alarm "regular"	○
Travelling alarm "white noise"	○

UNDERCARRIAGE	
	ZX95W-7
Additional counterweight +420 kg (only with rear blade)	○
Clamshell bracket	○
Cruise control	●
Parking brake	●
Rear dozer blade, prepared for trailer towing	●
Front dozer blade, rear outriggers (independently)	○
Front fender / rear fender	○
Tool box: left side (lockable)	●
Tool box: right side (lockable)	●
Towing hook bolted on blade	○
BKT twin tire 8.25-20 with spacer	●
ALLIANCE single tire 500/45 R20	○
2-Speed automatic transmission (35 km/h version)	●
2-Wheel steering	●
4-Wheel steering	○
4 Tie down brackets	●

● : Standard equipment ○ : Optional equipment — : Not applicable

FRONT ATTACHMENTS	
Auto-lubrication device (swing gear, boom, arm and bucket)	○
Bucket link A	●
Boom cylinder protector	●
Centralized lubrication system for upper frame	●
Centralized lubrication system for upper frame, boom and arm	○
Dirt seal on all bucket pins	●
Flanged pin	●
Hydraulic quick coupler piping	●
Link B	●

ATTACHMENT	
Additional pump (100 L/min)	○
Assist piping	○
Breaker and crusher piping	●
Breaker & crusher return line	●
Clamshell piping	○
Pilot accumulator	●
Tilt-rotator predisposition	○

MISCELLANEOUS	
ConSite	●
Digicode Anti-theft system	○
Global e-Service	●
Onboard information controller	●
Special paint (Company colour)	○
Standard tool kit	●

Standard and optional equipment may vary by country, so please consult your Hitachi dealer for details.

Prior to operating this machine, including satellite communication system, in a country other than a country of its intended use, it may be necessary to make modifications to it so that it complies with the local regulatory standards (including safety standards) and legal requirements of that particular country. Please do not export or operate this machine outside the country of its intended use until such compliance has been confirmed. Please contact your Hitachi dealer in case of questions about compliance.

These specifications are subject to change without notice. Illustrations and photos show the standard models, and may or may not include optional equipment, accessories, and all standard equipment with some differences in color and features. Before use, read and understand the Operator's Manual for proper operation.



KS-EN510EU