

Reliable solutions

**ZW220**

Tier 4 Final Certified

**200 hp** 149 kW  
Engine Output, Max, Gross  
(ISO 14396)

**194 hp** 145 kW  
Engine Output, Max, Net  
(ISO 9249)

**4.2 yd<sup>3</sup>** 3.2 m<sup>3</sup>  
Bucket capacity

**38,912 lbs** 17,650 kg  
Operating weight

**ZW250**

Tier 4 Final Certified

**253 hp** 186 kW  
Engine Output, Max, Gross  
(ISO 14396)

**246 hp** 181 kW  
Engine Output, Max, Net  
(ISO 9249)

**4.8 yd<sup>3</sup>** 3.7 m<sup>3</sup>  
Bucket capacity

**46,050 lbs** 20,890 kg  
Operating weight



# ZW220-6 and ZW250-6 NO COMPROMISE

With substantial loading capacity, powerful digging force and impressive travel speeds, the Hitachi ZW-6 wheel loaders offer exceptional levels of performance, without compromising on efficiency – thanks to low levels of fuel consumption.

The innovative engineering, reliable features and durable components on the ZW220-6 and ZW250-6 demonstrate Hitachi's capability for manufacturing construction machinery of the highest quality. It is also extremely versatile to meet the diverse needs of North American customers.



6. A TRACK RECORD FOR RELIABILITY



8. DURABILITY TO DEPEND ON



10. EXCEPTIONAL VERSATILITY



**12. DEDICATED TO QUALITY**



**16. EXPERTS IN TECHNOLOGY**

# DEMAND PERFECTION

The ZW220-6 and ZW250-6 have been designed and built using market-leading technology in Japan. Developed to perfection, with an emphasis on the environment, operator comfort and safety, it responds to customer demands for exceptional productivity at the lowest possible cost of ownership.



**Powerful performance**  
Quick power switch increases engine output when required.



**Industry-leading safety**  
360° visibility from the cab.



**Easy to operate**  
Multifunctional monitor shows information at a glance.



**Smooth operation**  
Ride control minimizes machine pitching.



**Superior comfort**  
Spacious cab with several storage compartments.





**Enhanced design**

Excellent rear view thanks to the curved engine hood.



**Quieter performance**

New materials in the cab absorb sound to reduce noise levels.



**Improved fuel efficiency**

Lock-up transmission and Tier 4 Final-compliant engine.



**Low running costs**

6% fuel saving in V-shaped loading (5% in load and carry operations).



**User-friendly**

Effortless control with the optional e-Stick Steering System.



**Convenient access**

Easy-to-open wide engine covers.

# A TRACK RECORD FOR RELIABILITY

Like all Hitachi wheel loaders, both the ZW220-6 and the ZW250-6 are renowned for their reliability to achieve optimum performance with minimum downtime. Both have proven to operate at high levels of efficiency, on a wide range of job sites. This is a testimony to the numerous easy-to-maintain features of the ZW series of wheel loaders

## Reduced cost

The new Tier 4 Final certified engine does not require a diesel particulate filter, which further reduces fuel consumption and maintenance costs.

## Improved fuel efficiency

The ZW220-6 and ZW250-6 demonstrate greater fuel efficiency than the previous models during V-shape loading, and load and carry operations. This results in considerable savings for running costs.

## Easy maintenance

For safer and easier maintenance, the battery disconnect switch is standard. This helps to avoid electrical accidents and retain battery energy during long-term storage.

## Quick access

The engine covers open fully for convenient access. This helps to ensure routine maintenance is completed quickly to ensure a reliable performance.



Easy access to the engine compartment.



ZW220



ZW250

Easy access battery compartment.



ZW220



ZW250

Tier 4 Final engine reduces fuel consumption.



Increased lift arm strength.



Optional clog resistant cooling cores enhance durability.





**i** The final pre-delivery inspection procedure for each Hitachi wheel loader is typical of Hitachi's dedication to manufacturing products of unfailing quality in response to customer needs.



# DURABILITY TO DEPEND ON

Hitachi's global reputation for producing robust construction machinery continues with its new wheel loaders. Designed and engineered to operate reliably across a wide range of demanding job sites, the ZW220-6 and the ZW250-6 are guaranteed to deliver a durable performance.



ZW250

The optional belly guard provides added protection.

## Added protection

The optional belly guard protects the machine powertrain and driveshaft from potential damage caused by materials on the ground.

## Strengthened components

The lift arm torsion of both the ZW220-6 and the ZW250-6 have been increased to meet customer demand. This also enhances productivity during lifting operations.

## Durable materials

High-quality radiators improve resistance to corrosion and enhance the overall durability of the ZW250-6 wheel loader.

## Maximum uptime

Anti-Clogging radiators, standard on the ZW250-6, Optional on the ZW220-6, are designed with wide spaced square-shaped fins, instead of triangular-shaped fins to resist clogging. This reduces cooling cores maintenance.

# EXCEPTIONAL VERSATILITY

The smooth and efficient operation of Hitachi wheel loaders makes them an ideal choice for a wide range of applications. Several features contribute to the overall versatility of these machines, and bring additional benefits of increased productivity, fuel efficiency and safety.

## **Efficient flexibility**

The quick power switch increases engine output when more power is instantly required, or when driving uphill.

## **Enhanced rear visibility**

The muffler and air intake have been repositioned and aligned to improve the rear-view visibility from the cab, enhancing safety on a variety of job sites.

## **High productivity**

The simultaneous movement of the bucket and lift arm ensures a smooth digging operation. The Hitachi flow control system ensures smooth lift arm starts and stops.

## **Improved fuel efficiency**

The five-speed transmission contributes to the versatility of the ZW220-6 and the ZW250-6, bringing additional benefits of increased productivity and fuel efficiency. A lock-up feature, available as standard on the ZW250-6 and larger machines, further reduces fuel consumption on loading and carrying applications.

## **Effective control**

To ensure a smooth drive on all kinds of terrain, the ride control feature prevents unnecessary pitching via the movement of lift arm cylinders.



Rear visibility has been enhanced by design modifications.



ZW220

The ride control feature ensures a smooth travel performance.



Urea is injected into the exhaust gas to reduce emissions.



Ground level access for easy maintenance.

**i** Hitachi conducts user tests to assess the features of its wheel loaders. Results have revealed an unrivaled level of control.



# DEDICATED TO QUALITY

Each new Hitachi wheel loader is rigorously tested to ensure it meets the highest possible standards of performance, reliability, comfort and safety. Built using high-quality components, the ZV220-6 is one of the quietest wheel loaders and offers the best all-round visibility in its class.

## Reduced emissions

A selective catalytic reduction (SCR) system injects urea into exhaust gas to reduce nitrous oxide from emissions. This cutting-edge technology not only helps the environment, but also complies with Tier 4 Final emission regulations.

## Easy access

The engine air filter has been relocated to the rear of the engine compartment, providing easier access at ground level for maintenance. The urea tank is also positioned for convenience.

## Excellent visibility

The 360° panoramic view from the spacious cab creates a comfortable working environment, and helps to increase safety and productivity. The rear-view camera also contributes to excellent all around visibility and safety on the job site.

## Improved comfort

Sound insulation has been improved in the cab to significantly reduce noise levels and provide a quieter working environment for operators. The low-noise engine also results in a quieter performance, which makes it suitable for working in urban areas.



NO DPF SCR system reduces emissions.



The 360° panoramic view provides exceptional visibility.



Easy access for maintenance from ground level.

**i** Hitachi conducts user tests to assess the features of its wheel loaders. Results have revealed an unrivaled level of control.



# CONSISTENT QUALITY

Quality is high on the agenda during the development of Hitachi construction machinery. Every wheel loader is built using the finest components, and is tested to ensure it meets the highest possible standards of performance, reliability, safety and comfort. As a result, the ZV250-6 is not only one of the quietest in its class, but it also offers the best all around visibility.

## Reduced emissions

A selective catalytic reduction (SCR) system injects urea into exhaust gas to reduce nitrous oxide from emissions. This cutting-edge technology not only helps the environment, but also complies with Tier 4 Final emission regulations.

## Easy access

The engine air filter has been relocated to the rear of the engine compartment, providing easier access at ground level for maintenance. The urea tank is also positioned for convenience.

## Excellent visibility

The 360° panoramic view from the spacious cab creates a comfortable working environment, and helps to increase safety and productivity. The rear-view camera also contributes to excellent all around visibility and safety on the job site.

## Improved comfort

Sound insulation has been improved in the cab to significantly reduce noise levels and provide a quieter working environment for operators. The low-noise engine also results in a quieter performance, which makes it suitable for working in urban areas.



The SCR system reduces emissions.

# EXPERTS IN TECHNOLOGY

Hitachi uses advanced technology to create construction machinery that offers exceptional levels of performance at the lowest possible cost of ownership. Its relentless pursuit of innovation enables it to enhance the experience of customers and constantly raise industry standards.

### **Reduced maintenance**

The new Tier 4 Final certified engine contains a high-volume cooled exhaust gas recirculation (EGR) system, a common rail-type fuel injection system and a diesel oxidation catalyst (DOC) without DPF. This helps to reduce maintenance requirements.

### **Smaller environmental impact**

The standard auto shutdown feature helps to prevent fuel waste, as well as reduce noise levels, exhaust emissions and CO<sub>2</sub> levels of the ZW220-6 and ZW250-6 wheel loaders.

### **Multifunctional display**

A large LCD color monitor shows all the information required to operate the Hitachi ZW-6 wheel loader. This includes power mode, oil temperature, and fuel and urea levels, which is useful for easy maintenance. It also includes the display for the easy-to-use rear camera, which enhances visibility for safe operation.

### **Remote monitoring**

Global e-Service allows both ZW220-6 and the ZW250-6 owners to monitor their Hitachi machines remotely via Owner's Site (24/7 online access) and ConSite (an automatic monthly report). These help to maximize efficiency, minimize downtime and improve overall performance.

### **User-friendly operation**

The optional Joystick Steering System enables operators to reach high levels of productivity with effortless steering, and incorporates a number of useful functions.

### **Optimum performance**

Hitachi ZW-6 wheel loaders are fitted with a multifunctional LCD color monitor that shows useful information at a glance, such as fuel and urea levels, oil temperature and power modes. It ensures an optimum performance and easy maintenance. It also includes the display for the easy-to-use rear-view camera, which enhances visibility for a safe operation.





The LCD monitor shows the machine's status and settings.



The optional e-Stick Steering System provides exceptional control.



Urea levels can be checked from the cab.



Remote monitoring using Global e-Service maximizes efficiency.

# REDUCING THE TOTAL COST OF OWNERSHIP

Hitachi has created the After Sales Solutions Program to ensure optimum efficiency, as well as minimal downtime, reduced running costs and high resale values.

## Global e-Service

Hitachi has developed two remote monitoring systems as part of its Global e-Service online application. Owner's Site and ConSite are an integral part of the wheel loader, which sends operational data daily via GMS to [www.globaleservice.com](http://www.globaleservice.com). This allows immediate access to the Owner's Site, and the vital information that is required for support on job sites.

Comparing the ratio of operating and non-operating hours helps to enhance efficiency. Effective management of maintenance programs helps to maximize availability.

Running costs can also be managed by analyzing the fuel consumption. The location and movements of each machine are clearly displayed for essential planning.

An automatic service report — ConSite — sends a monthly email summarizing the information from Global e-Service for each machine. This includes: daily working hours and fuel consumption data; statistics on the operating mode ratio, plus a comparison for fuel consumption/efficiency, and CO<sub>2</sub> emissions.

## Technical support

Each Hitachi service technician receives full technical training from Hitachi Construction Machinery Americas Inc. (HCMA) in the USA. These sessions provide access to the same technical knowledge available within the Hitachi quality assurance departments and design centers. Technicians combine this global expertise with the local language and culture of the customer to provide the highest level of after-sales support.



Global e-Service



Technical support



Hitachi Parts

## Extended warranty and service contracts

Every new Hitachi ZW-6 model is covered by a full manufacturer's warranty. For extra protection — due to severe working conditions or to minimize equipment repair costs — Hitachi dealers offer a unique extended warranty called HELP (Hitachi Extended Life Program) and comprehensive service contracts. These can help to optimize the performance of each machine, reduce downtime and ensure higher resale values.

## Parts

Hitachi offers a wide range, and high availability, of parts located in the new 400,000 sq. ft. Parts Depot centrally located just outside of Atlanta, Georgia.

- Hitachi Genuine Parts: allow machines to work longer, with lower running and maintenance costs.
- Hitachi Select Parts and Genuine Parts: are of proven quality and come with the manufacturer's warranty.

- Performance Parts: to cope with highly demanding conditions, they have been engineered for greater durability, better performance or longer life.

- Genuine Hitachi rebuilt components are available from HCMA's in-house rebuild center and are offered with a standard warranty.

Whatever the choice, the renowned quality of Hitachi construction machinery is assured.

ENGINE	
Gross power (ISO 14396)	200 HP/1,600 RPM (149 kW/1,600 RPM)
Net power (ISO 9249)	194 HP/1,600 RPM (145 kW/1,600 RPM)
Make/Model	Cummins QSB6.7 diesel engine
Type	4-cycle, water-cooled, direct injection with turbocharger and air cooled intercooler
Fuel type	#2 Diesel (Requires ultra-low sulfur fuel.)
Fuel injection pump	Electronically controlled, common rail type
Governor	All speed electrical type
Cooling module type	Hydraulic-driven, suction-type fan, pressurized radiator
Number of cylinders	6
Bore and stroke	4.2" x 4.9" (107mm x 124mm)
Total displacement	408.2 in <sup>3</sup> (6.69 liters)
Alternator	DC 24V-65A (1.56 kW)
Air cleaner	Dry type (double element)
Starter motor	DC 24V-10.6 HP (7.8 kW)
Battery	DC 12V-1,000 CCA (108 Ah), 2 units

TORQUE CONVERTER AND TRANSMISSION		
Torque converter	3-element, single-stage, 1-phase	
Transmission	Countershaft type, Full power shift	
	Normal Mode	Power Mode
Speeds: Forward	1st: 3.9 MPH (6.2 km/hr)	1st: 4.0 MPH (6.5 km/hr)
	2nd: 6.6 MPH (10.6 km/hr)	2nd: 6.9 MPH (11.1 km/hr)
	3rd: 9.9 MPH (16.0 km/hr)	3rd: 10.4 MPH (16.8 km/hr)
	4th: 14.8 MPH (23.8 km/hr)	4th: 15.5 MPH (25.0 km/hr)
	5th: 22.4 MPH (36.0 km/hr)	5th: 22.4 MPH (36.0 km/hr)
Speeds: Reverse	1st: 4.0 MPH (6.5 km/hr)	1st: 4.2 MPH (6.8 km/hr)
	2nd: 6.9 MPH (11.1 km/hr)	2nd: 7.3 MPH (11.7 km/hr)
	3rd: 15.5 MPH (24.9 km/hr)	3rd: 16.3 MPH (26.2 km/hr)

SYSTEMS REFILL CAPACITY		
LOCATION	GALLONS	LITERS
Fuel tank (diesel fuel)	67.4	255
Engine lubricant (including oil pan)	6.6	25
Engine coolant	8.7	33
T/M & T/C	7.1	27
Axle (front/rear)	8.5/8.5	32/32
Hydraulic oil tank	30.1	114
Hydraulic system (including hydraulic tank)	48	180
DEF/AdBlue® tank	6.6	25.1

HYDRAULIC AND STEERING SYSTEM		
Steering type	Articulated frame steering	
Steering mechanism	Hydraulic power steering unit, pilot operated type	
Lift (boom) cylinder	Two (2) double-acting piston type: 5.1" x 34.7" (130mm x 880mm)	
Tilt (bucket) cylinder	One (1) double-acting piston type: 6.496" x 20.078" (165mm x 510mm)	
Steering cylinder	Two (2) double-acting piston type: 2.8" x 17.4" (70mm x 442mm)	
Main oil pump	Variable Piston type: 72.6 GPM/710 PSI @ 2,200 RPM (275 LPM/4.9 MPa @ 2,200 RPM)	
Pilot oil pump	Gear type: 9.3 GPM/570 PSI @ 2,200 RPM (35.1 LPM/3.9 MPa @ 2,200 RPM)	
Relief valve set pressure	Loading	3,974 psi, 27.4 MPa (280 kgf/cm <sup>2</sup> )
	Steering	3,974 psi, 27.4 MPa (280 kgf/cm <sup>2</sup> )
HYDRAULIC CYCLE TIME* front end loading, Z bar linkage system		
	Normal Mode	Power Mode
Lifting time (at full load)	5.9 sec.	5.6 sec.
Lowering time (empty)	3.3 sec.	3.3 sec.
Bucket dumping time	1.6 sec.	1.5 sec.
TOTAL	10.8 sec.	10.4 sec.

\* Measured in accordance with SAE J732C

AXLE SYSTEM	
Drive system	4-wheel drive
Front and rear axle	Semi-floating type
Tires	23.5-25-20PR (L-3) Tubeless
	23.5R25 (L-3) Radial
Reduction and differential gear	Two stage reduction with limited slip differentials
Final reduction gear	Inboard mounted, internal planetary gear
Oscillation angle	Total 24° (+12°, -12°)





BRAKE SYSTEM	
Service brakes	Inboard mounted fully hydraulic 4-wheel wet disc brake. Front & rear independent brake circuit.
Parking/Emergency brake	Spring-applied, hydraulically-released dry disc type with external output shaft. Located on driveline.

### Remarks

- Materials and specifications are subject to change without notice and without any obligation on the part of the manufacturer.
- This information, while believed to be completely reliable, is not to be taken as warranty for which we assume legal responsibility.
- Dumping clearance and reach are measured from bucket edge in accordance with SAE J732C.
- Counterweight should not be used with tire ballast.
- This specification sheet may contain attachments and optional equipment not available in your area.

Please contact your local HCMA dealer for additional information.

**BUCKET DATA**

			Standard Boom				High Lift Boom
			General Purpose		Material Handling		Material Handling
			Straight Edge With Bolt-on Cutting Edge	Straight Edge With Teeth and Segments	Straight Edge With Bolt-on Cutting Edge	Straight Edge With Bolt-on Cutting Edge	
							
Capacity	Heaped	yd <sup>3</sup> (m <sup>3</sup> )	4.2 (3.2)	4.2 (3.2)	4.7 (3.6)	4.2 (3.2)	
	Struck	yd <sup>3</sup> (m <sup>3</sup> )	3.5 (2.7)	3.5 (2.7)	4.0 (3.1)	3.5 (2.7)	
<b>A</b>	Maximum dumping clearance	ft-in (mm)	9'6" (2,890)	9'3" (2,810)	9'5" (2,860)	10'10" (3,300)	
<b>B</b>	Dumping reach (to front of bucket edge or tooth)	ft-in (mm)	3'8" (1,130)	4' (1,220)	3'10" (1,170)	4'3" (1,290)	
<b>C</b>	Max. hinge pin height	ft-in (mm)	13'5" (4,090)	13'5" (4,090)	13'5" (4,090)	14'9" (4,500)	
<b>D</b>	Digging depth (with bucket level)	in (mm)	4" (100)	4" (100)	4" (100)	7" (180)	
Breakout force		lb (kN)	32,630 (145)	32,630 (145)	31,050 (138)	29,700 (132)	
Bucket tilt-back angle	at ground level	degree	50°	50°	50°	48°	
	<b>E</b> at carry position	degree	50°	50°	50°	50°	
Overall	<b>F</b> Length	ft-in (mm)	27'3" (8,310)	27'8" (8,430)	27'6" (8,370)	28'11" (8,820)	
	<b>G</b> Height (up to cab top)	ft-in (mm)	11' (3,375)	11' (3,375)	11' (3,375)	11' (3,375)	
	<b>H</b> Height (bucket fully raised)	ft-in (mm)	17'10" (5,440)	17'10" (5,440)	18'1" (5,510)	19'2" (5,850)	
	<b>I</b> Width (outside tire)	ft-in (mm)	9'2" (2,785)	9'2" (2,785)	9'2" (2,785)	9'2" (2,785)	
	<b>J</b> Width (outside bucket)	ft-in (mm)	9'7" (2,910)	9'7" (2,910)	9'7" (2,910)	9'7" (2,910)	
<b>K</b>	Tread	ft-in (mm)	7'1" (2,160)	7'1" (2,160)	7'1" (2,160)	7'1" (2,160)	
<b>L</b>	Wheel base	ft-in (mm)	10'10" (3,300)	10'10" (3,300)	10'10" (3,300)	10'10" (3,300)	
Clearance Circle (bucket carry position)	<b>M</b> at outside of bucket	ft-in (mm)	22'10" (6,960)	22'11" (6,990)	22'11" (6,980)	23'6" (7,160)	
	at outside of tire	ft-in (mm)	20'9" (6,325)	20'9" (6,325)	20'9" (6,325)	20'9" (6,325)	
<b>N</b>	Minimum ground clearance	ft-in (mm)	1'6" (450)	1'6" (450)	1'6" (450)	1'6" (450)	
<b>O</b>	Full articulation angle	degree	37°	37°	37°	37°	
Operating weight (with ROPS cab)		lb (kg)	38,912 (17,650)	38,978 (17,680)	39,088 (17,730)	39,352 (17,850)	
Static tipping load (with ROPS cab)	Straight	lb (kg)	32,849 (14,900)	32,739 (14,850)	32,584 (14,780)	26,191 (11,880)	
	Full turn	lb (kg)	29,101 (13,200)	29,013 (13,160)	28,858 (13,090)	23,082 (10,470)	

Note: All dimensions, weight and performance data based on ISO 6746-1:1987, ISO 7131:2009 and ISO 7546:1983

\* Static tipping load and operating weight marked with\* include 23.5-25-20PR (L3) tires (No ballast) with lubricants, full fuel tank and operator.

Machine stability and operating weight depend on counterweight, tire size and other attachments.

**DIMENSIONS**

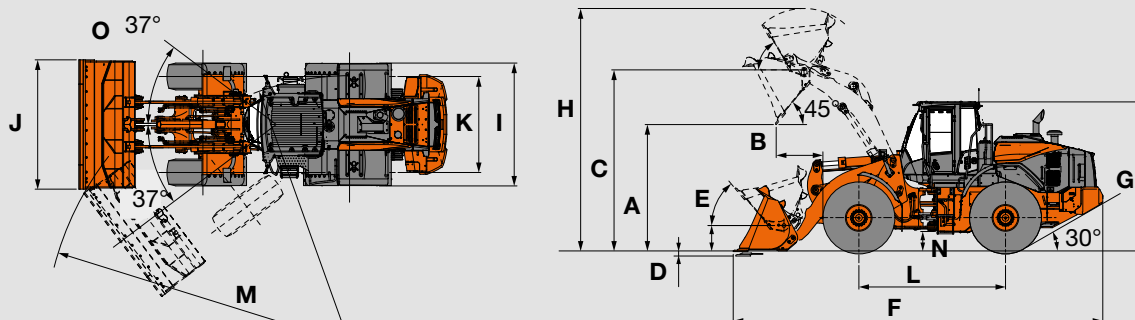

Equipped with 23.5-25-20PR (L3) tubeless tire and ROPS cab.

## ZW220-6

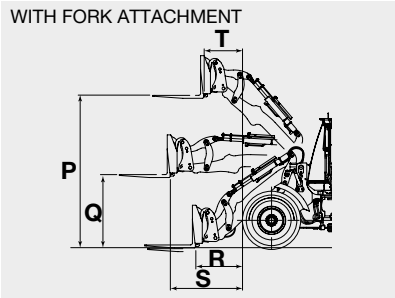

		ISO (72)	418 (72)
<b>P</b> Max. stacking height	ft	12'10"	12'11"
<b>Q</b> Height of fork at maximum reach	ft	6'2"	6'3"
<b>R</b> Reach at ground level	ft	4'4"	4'
<b>S</b> Max. reach	ft	6'2"	5'11"
<b>T</b> Reach at max. stacking height	ft	3'6"	3'5"
Tipping load	Straight	lbf	17,405
	Full turn	lbf	15,418
Max. payload per EN 474-3, 80%	lb	12,335	11,966
Max. payload per EN 474-3, 60%	lb	9,251	8,975
SAE allowable load	lb	7,709	7,479
Operating weight *	lb	39,580	40,052

Note: All dimensions, weight and performance data based on ISO 6746-1:1987, ISO 7137:1997, ISO 7546:1983 and ISO 8313:1989

\* Static tipping load and operating weight marked with\* include 23.5-25-20PR (L3) tires (No ballast) with lubricants, full fuel tank and operator. Machine stability and operating weight depend on counterweight, tire size and other attachments.

## WEIGHTS AND DIMENSIONS

		Operating Weight	Tipping Load			Overall Width (Outside Tire)	Overall Height	Overall Length
			Straight	Full Turn				
Remove ROPS cab (for transport only)	lb (kg)	-1,320 (-600)	-1,010 (-460)	-900 (-410)	in (mm)		-5 1/2 (-140)	
Install Refuse Counterweight	lb (kg)	-550 (-250)	-1,480 (-670)	-1,300 (-590)	in (mm)			
Belly guard (transmission)	lb (kg)	+200 (+90)	+175 (+80)	+155 (+70)	in (mm)			
Tires: 23.5R25 (L-3)	lb (kg)	+200 (+90)	+150 (+70)	+130 (+60)	in (mm)			
Belly guard (front & rear frame)	lb (kg)	+170 (+370)	+120 (+260)	+110 (+240)	in (mm)			
Emergency steering (Secondary steering)	lb (kg)	+70 (+30)	+0 (+0)	+0 (+0)	in (mm)			
Full covered rear fender	lb (kg)	+90 (+40)	+0 (+0)	+0 (+0)	in (mm)			
Bracket for rotating beacon	lb (kg)	+20 (+10)	+0 (+0)	+0 (+0)	in (mm)			

## BUCKET SELECTION CHART

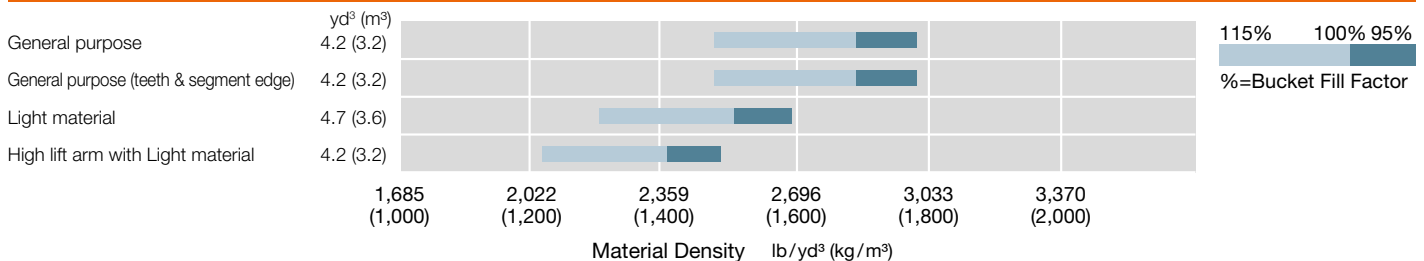

Specs highlighted in orange denote Canada only.

## STANDARD EQUIPMENT

### ENGINE

Air cleaner, double element
Auto idle shut down
Cold start (intake air heater)
Cooling fan, automatic reversible, swing-out type
Cummins QSB6.7 diesel engine
EGR (exhaust gas recirculation)
Engine block heater 120V
Fuel filter (Main)
Fuel pre-filter, w/water separator
Pre-Cleaner (SyKlone)
SCR (selective catalytic reduction) catalyst and DOC (diesel oxidation catalyst)
VGT (variable geometry turbocharger)
Work mode selector

### POWERTRAIN

Brakes, service
Enclosed wet disc
Dual system
Inboard mounted
Brake, parking
Spring applied
Oil pressure released
Dry disc type
Differential, limited slip type (F/R)
Down-shift switch
Drive shafts, low maintenance
F-R direction selector (2-column mounted/console mounted)
1st speed hold switch on side console
Quick Power switch
Transmission, automatic w/load sensing system.
Transmission declutch (3-position L/H/Off)
Transmission mode selection (3-position AUTO1/MAN/AUTO2)
Universal joints, sealed

### HYDRAULIC SYSTEM

Auxiliary (optional, lever)
Boom kick-out, dual (operator adjustable in cab)
Bucket positioner (horizontal)
Control lever, single, pilot-assisted (US market only, opt in CA market)
Control lever lock (electric)
Control valve, 4-spool
Lift arm
Bucket
QC control (switch)
Pump, variable displacement, load-sensing
Ride control w/load sensing valve and automatic shut-off
Quick coupler control lines and controls
Steering, pilot
System; open-center, high-pressure, load-sensing
Valve, anti-drift

### ELECTRICAL

24-volt electrical system
Alternator, (65 amp)
Back-up alarm
Batteries (2), 12V, 1,000 CCA
Battery disconnect switch
Converter, 12V/15 Amp
Horn, dual electric
Instrument panel, LCD, color
Lights:
2 Headlights (halogen)
4 Forward working lights (LED)
4 Rear working lights (LED)
2 Stop/tail/backup (LED)
Turn signal w/4-way flashers/marker

### CAB

ROPS cab: enclosed cab with sound suppression, front & rear wipers and washers, two rear view and side mirrors, tinted glass, full view latch-back doors, sliding side windows.
Accessory outlet, 12v
Adjustable armrest/console
Air conditioner/heater/pressurizer
AM/FM/WB radio with AUX input and Bluetooth
Ashtray
Cab dome lamps (2)
Cigarette lighter, 24V
Coat hook
Cup holder (2)
Floormat, sweep-out
Prepped for Loadrite Scale
Retractable seat belt (3-inch)
ROPS/FOPS certified, ISO 3449 Level II compliance
Seat, premium, heated w/ TLV suspension
Steering column, telescoping and tilting w/quick-release pedal
Steering wheel
Storage box (heated/cooled)
Storage tray
Sun visor

### OTHERS

Articulation locking bar
Counterweight
Drawbar
Engine block heater
Fire extinguisher, 5lb., 2A:10B:C rated (w/mounting) (US market only)
Global e-service, telematic monitoring system
Ladders, inclined
Lifting eyes
Linkage pins, HN bushing
Neutral safety start
Rear grill, hinged
Steps, rear
Vandalism protection
Z-bar loader linkage

### ALARMS, GAUGES, INDICATORS

Alarms (visual & audible)	Aftertreatment device
	Air cleaner element
	Axle oil temperature
	Battery discharge warning
	Brake oil low pressure
	CAN network system
	DEF/AdBlue tank level/quality/system
	Engine coolant temp
	Engine oil low pressure
	Engine trouble
Engine warning	
Fuel filter (water in fuel)	
Hydraulic oil level	
Hydraulic oil temperature	
Main pump oil pressure	
Transmission oil temp	
Transmission warning	
Gauges	DEF/AdBlue tank level
	Engine coolant temperature
	Fuel gauge
	Speedometer
	Tachometer
Indicators	Transmission oil temperature
	Aftertreatment device
	Air conditioner display
	Auto idle shutdown
	Boom kick-out, dual
	Cold start
	Control lever lock
	Declutch
	ECO-Operating Status
	Engine warning
	Fan reverse rotation
	F-N-R Selection
	F-N-R Switch enable
	High beam
	Parking brake
Shift hold	
Time/Operating hour/ODO	
Transmission mode and status	
Turn signal w/4-way flashers/Marker	
Work light	
Work mode (Normal, Power)	

### OPTIONAL EQUIPMENT

Belly Guard, rear chassis
Belly guard, front chassis, transmission (rear)
Cooling system cores, wide fin
Counterweight, (solid tire & logging applications)
Dual lever hydraulic control (US market only)
E-Stick steering
Emergency steering system
Front and full covered rear fenders with mud flaps (23.5 Tire) (opt in US market)
Heated rear view mirror
High lift arm
Mount bracket, wiring harness and switch for rotating lamp (without beacon) (Canada Only)
Quick coupler & attachments
Rear view camera mount (high mount separated type)

Standard and optional equipment may vary by country, so please consult your Hitachi dealer for details.

# SPECIFICATIONS

ZW250-6

Model Name: ZW250-6, EPA Tier 4 Final/EU Stage IV Certified

## ENGINE

Gross power (ISO 14396)	253 HP/2,000 RPM (186 kW/2,000 RPM)
Net power (ISO 9249)	246 HP/2,000 RPM (181 kW/2,000 RPM)
Make/Model	Cummins QSB6.7 diesel engine
Type	4-cycle, water-cooled, direct injection with turbocharger and air cooled intercooler
Fuel type	#2 Diesel (Requires ultra-low sulfur fuel.)
Fuel injection pump	Electronically controlled, common rail type
Governor	All speed electrical type
Cooling module type	Forced circulation type
Number of cylinders	6
Bore and stroke	4.21" x 4.88" (107mm x 124mm)
Total displacement	408 in <sup>3</sup> (6.69 liters)
Alternator	AC 24V – 65A (15.6 kW)
Air cleaner	Dry type (double element) with restriction indicator
Starter motor	DC 24V – 10.5 HP (7.8 kW)
Battery	12V – 765 CCA (160Ah), 2 units

## TORQUE CONVERTER AND TRANSMISSION

Torque converter	3-element, single-stage, 2-phase w/lock-up clutch			
Transmission	Torque converter, countershaft type powershift with computer-controlled automatic shift and manual shift features included			
	Normal Mode	Power Mode	Normal Mode w/Lock-up clutch	Power Mode w/Lock-up clutch
1st:	3.6 MPH (5.8 km/hr)	3.6 MPH (5.8 km/hr)	3.6 MPH (5.8 km/hr)	3.6 MPH (5.8 km/hr)
2nd:	6.3 MPH (10.1 km/hr)	6.5 MPH (10.4 km/hr)	6.5 MPH (10.5 km/hr)	6.7 MPH (10.8 km/hr)
Speeds: Forward	3rd: 9.0 MPH (14.5 km/hr)	9.6 MPH (15.5 km/hr)	9.6 MPH (15.5 km/hr)	10.1 MPH (16.3 km/hr)
	4th: 13.6 MPH (21.9 km/hr)	15.3 MPH (24.6 km/hr)	15.1 MPH (24.3 km/hr)	15.8 MPH (25.4 km/hr)
	5th: 21.7 MPH (35.0 km/hr)	21.7 MPH (35.0 km/hr)	24.5 MPH (39.5 km/hr)	24.5 MPH (39.5 km/hr)
Speeds: Reverse	1st: 3.8 MPH (6.1 km/hr)	3.8 MPH (6.1 km/hr)	4.0 MPH (6.5 km/hr)	4.1 MPH (6.6 km/hr)
	2nd: 6.6 MPH (10.6 km/hr)	7.1 MPH (11.4 km/hr)	6.6 MPH (10.7 km/hr)	7.3 MPH (11.8 km/hr)

## SYSTEMS REFILL CAPACITY

LOCATION	GALLONS	LITERS
Fuel tank (diesel fuel)	89.9	340
Engine lubricant (including oil pan)	6.6	25
Engine coolant	10.3	39
T/M & T/C	7.1	27
Axle (front/rear)	11.4/11.4	43/43
Hydraulic oil tank	30.4	115
Hydraulic system (including hydraulic tank)	47.6	180
DEF/AdBlue® tank	9.2	35

## HYDRAULIC AND STEERING SYSTEM

Steering type	Articulated frame steering	
Steering mechanism	Hydraulic power steering unit, double-acting piston type	
Lift (boom) cylinder	Two (2) double-acting piston type: 5.1" x 37.0" (130mm x 940mm)	
Tilt (bucket) cylinder	Two (2) double-acting piston type: 6.5" x 20.9" (165mm x 530mm)	
Steering cylinder	Two (2) double-acting piston type: 2.8" x 21.3" (70mm x 542mm)	
Main/Steering oil pump	Variable displacement axial plunger pump: 72.6 GPM/4,264 PSI @ 2,200 RPM (275 LPM/29.4 MPa @ 2,200 RPM)	
Brake & Pilot oil pump	Fixed displacement gear pump: 9.3 GPM/2,245 PSI @ 2,200 RPM (35.1 LPM/15.5 MPa @ 2,200 RPM)	
Fan oil pump	Fixed displacement gear pump: 16.5 GPM/2,495 PSI @ 2,200 RPM (62.5 LPM/17.2 MPa @ 2,200 RPM)	
Relief valve set pressure	Control	4,264 psi, 29.4 MPa (300 kgf/cm <sup>2</sup> )
	Steering	4,264 psi, 29.4 MPa (300 kgf/cm <sup>2</sup> )
HYDRAULIC CYCLE TIME* front end loading, Z bar linkage system		

	Normal Mode	Power Mode
Lifting time (at full load)	6.4 sec.	5.7 sec.
Lowering time (empty)	3.6 sec.	3.6 sec.
Bucket dumping time	1.9 sec.	1.8 sec.
TOTAL	11.9 sec.	11.1 sec.

\* Measured in accordance with SAE J732C

## AXLE SYSTEM

Drive system	4-wheel drive
Front and rear axle	Semi-floating type
Tires	23.5 R25 (L-3)
Reduction and differential gear	Two-stage reduction with limited slip differential
Final reduction gear	Inboard mounted, heavy duty planetary gear
Oscillation angle	Total 20° (+10 / -10)°

## BRAKE SYSTEM

Service brakes	Inboard mounted fully hydraulic 4-wheel disc brake. Front and rear independent brake circuit.
Parking/Emergency brake	Spring-applied, hydraulically-released. Located in transmission.







## Remarks

- Materials and specifications are subject to change without notice and without any obligation on the part of the manufacturer.
- This information, while believed to be completely reliable, is not to be taken as warranty for which we assume legal responsibility.
- Dumping clearance and reach are measured from bucket edge in accordance with SAE J732C.
- Counterweight should not be used with tire ballast.
- This specification sheet may contain attachments and optional equipment not available in your area.

Please contact your local HCMA dealer for additional information.



**BUCKET DATA**

		Standard Arm					High Lift Arm	
		General Purpose			Light Material	Rock Bucket	Light Material	
		Bolt-on Cutting Edge	Bolt-on Cutting Edge	Belt-on Teeth/Segment Edge	Bolt-on Cutting Edge	Bolt-on Teeth	Bolt-on Cutting Edge	
								
Capacity	Heaped	yd <sup>3</sup> (m <sup>3</sup> )	4.6 (3.5)	4.8 (3.7)	4.8 (3.7)	5.2 (4.0)	3.8 (2.9)	4.8 (3.7)
	Struck	yd <sup>3</sup> (m <sup>3</sup> )	4.0 (3.1)	4.3 (3.3)	4.3 (3.3)	4.6 (3.5)	3.3 (2.5)	4.3 (3.3)
<b>A</b>	Maximum dumping clearance	ft-in (mm)	9'10" (2,975)	9'11" (3,000)	9'6" (2,890)	9'9" (2,960)	9'6" (2,895)	11'4" (3,450)
<b>B</b>	Dumping reach (to front of bucket edge or tooth)	ft-in (mm)	3'7" (1,100)	3'5" (1,040)	3'9" (1,150)	3'7" (1,080)	3'11" (1,190)	3'7" (1,080)
<b>C</b>	Max. hinge pin height	ft-in (mm)	13'9" (4,190)	13'11" (4,250)	13'11" (4,250)	13'11" (4,250)	13'9" (4,190)	15'5" (4,710)
<b>D</b>	Digging depth (with bucket level)	in (mm)	4'4" (110)	3" (80)	3" (80)	3" (80)	4'9" (120)	4" (100)
Breakout force		lb (kN)	35,330 (157)	37,090 (165)	37,770 (168)	35,520 (158)	39,380 (175)	34,170 (152)
Bucket tilt-back angle	at ground level	degree	43°	43°	43°	43°	43°	44°
	<b>E</b> at carry position	degree	50°	50°	50°	50°	50°	50°
Overall	<b>F</b> Length	ft-in (mm)	27'9" (8,460)	27'9" (8,460)	28'3" (8,610)	27'11" (8,510)	28'3" (8,600)	29'3" (8,920)
	<b>G</b> Height (up to cab top)	ft-in (mm)	11'4" (3,440)	11'4" (3,460)	11'4" (3,460)	11'4" (3,460)	11'4" (3,440)	11'4" (3,460)
	<b>H</b> Height (bucket fully raised)	ft-in (mm)	18'7" (5,680)	18'8" (5,680)	18'8" (5,680)	18'10" (5,730)	18'11" (5,520)	20'2" (6,140)
	<b>I</b> Width (outside tire)	ft-in (mm)	9'5" (2,870)	9'5" (2,870)	9'5" (2,870)	9'5" (2,870)	9'5" (2,870)	9'9" (2,980)
	<b>J</b> Width (outside bucket)	ft-in (mm)	9'10" (2,980)	9'10" (2,980)	9'10" (2,980)	9'10" (2,980)	9'10" (2,980)	10'2" (3,100)
<b>K</b>	Tread	ft-in (mm)	7' (2,200)	7'5" (2,260)	7'5" (2,260)	7'5" (2,260)	7' (2,200)	7'5" (2,260)
<b>L</b>	Wheel base	ft-in (mm)	10'10" (3,310)	10'10" (3,310)	10'10" (3,310)	10'10" (3,310)	10'10" (3,310)	10'10" (3,310)
Clearance Circle (bucket carry position)	<b>M</b> at outside of bucket	ft-in (mm)	19'10" (6,050)	19'11" (6,080)	19'11" (6,080)	19'11" (6,080)	19'10" (6,050)	19'11" (6,080)
	at outside of tire	ft-in (mm)	23'1" (7,050)	23'5" (7,140)	23'6" (7,160)	23'6" (7,150)	23'3" (7,060)	24' (7,320)
<b>N</b>	Minimum ground clearance	ft-in (mm)	1'5" (420)	1'7" (480)	1'7" (480)	1'7" (480)	1'5" (420)	1'7" (480)
<b>O</b>	Full articulation angle	degree	37°	37°	37°	37°	37°	37°
Operating weight (with ROPS cab)*		lb (kg)	45,580 (20,670)	46,050 (20,890)	46,120 (20,920)	46,340 (21,020)	46,020 (20,870)	46,620 (21,150)
Static tipping load (with ROPS cab)*	Straight	lb (kg)	36,470 (16,540)	35,860 (16,270)	35,800 (16,240)	35,110 (15,930)	36,250 (16,440)	29,010 (13,160)
	Full turn	lb (kg)	32,130 (14,570)	31,590 (14,330)	31,520 (14,300)	30,930 (14,030)	31,950 (14,490)	25,570 (11,600)

Note: All dimensions, weight and performance data based on ISO 6746-1:1987, ISO 7131:2009 and ISO 7546:1983

\* Static tipping load and operating weight marked with\* include 23.5 R25 (L3) tires (No ballast) with lubricants, full fuel tank and operator. Machine stability and operating weight depend on counterweight, tire size and other attachments.

**DIMENSIONS**

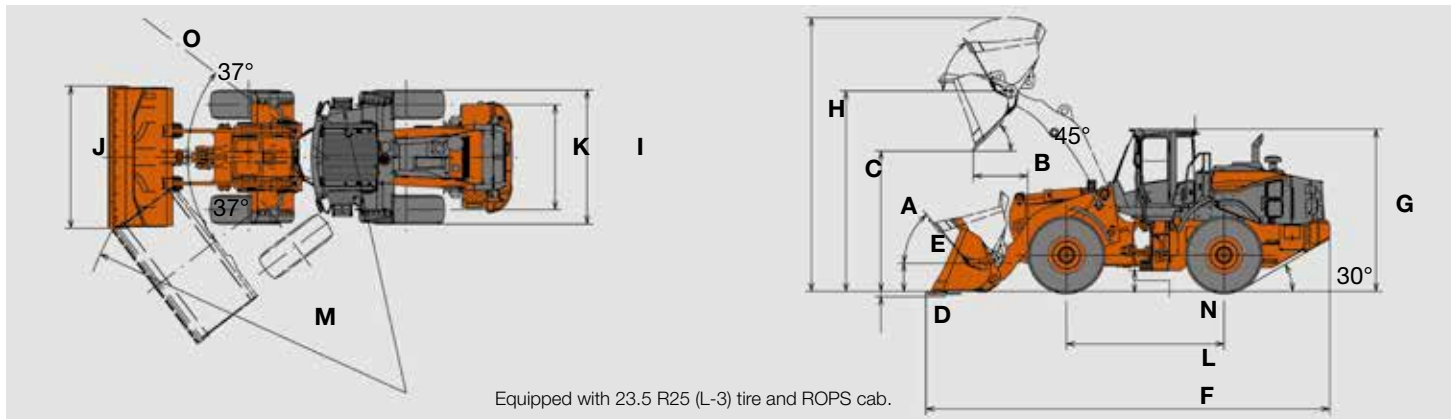

## ZW250 FORK SPECIFICATIONS

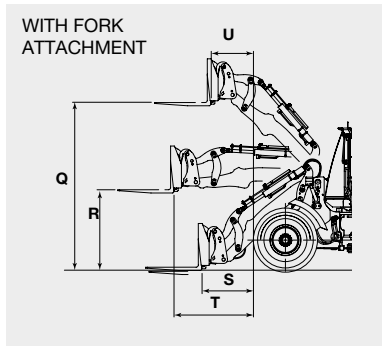

Attachment Type		ISO (72")	416 (72")
<b>Q</b>	Max. stacking height	ft 13'1"	13'2"
<b>R</b>	Height of fork at maximum reach	ft 5'11"	6'1"
<b>S</b>	Reach at ground level	ft 4'8"	4'4"
<b>T</b>	Max. reach	ft 6'4"	6'1"
<b>U</b>	Reach at max. stacking height	ft 3'6"	3'2"
Tipping load	Straight	lbf 19,222	19,018
	Full turn	lbf 16,932	16,751
Max. payload per EN 474-3, 80%		lb 13,545	13,401
Max. payload per EN 474-3, 60%		lb 10,159	10,051
SAE allowable load		ft 8,466	8,376
Operating weight *		lb 47,181	47,533

Note: All dimensions, weight and performance data based on ISO 6746-1:1987, ISO 7137:1997, ISO 7546:1983 and ISO 8313:1989

\* Static tipping load and operating weight marked with\* include 26.5R25 (L3) tires (No ballast) with lubricants, full fuel tank and operator. Machine stability and operating weight depend on counterweight, tire size and other attachments.

## WEIGHTS AND DIMENSIONS

	lb (kg)	Operating Weight	Tipping Load		in (mm)	Overall Width (Outside Tire)	Overall Height	Overall Length
			Straight	Full Turn				
Belly guard	lb (kg)	+410 (+190)	+300 (+140)	+260 (+120)	in (mm)			
Tires:	lb (kg)	+1,230 (+560)	+920 (+420)	+810 (+370)	in (mm)	+3.3 (+85)	+2.4 (+60)	+2.0 (+50)
	lb (kg)	+880 (+400)	+660 (+300)	+570 (+260)	in (mm)	+0.6 (+15)	+1.2 (+30)	-1.0 (-25)
Optional counterweight	lb (kg)	+0 (+0)	+0 (+0)	+0 (+0)	in (mm)			
Belly guard (rear frame)	lb (kg)	+0 (+0)	+0 (+0)	+0 (+0)	in (mm)			

## BUCKET SELECTION CHART

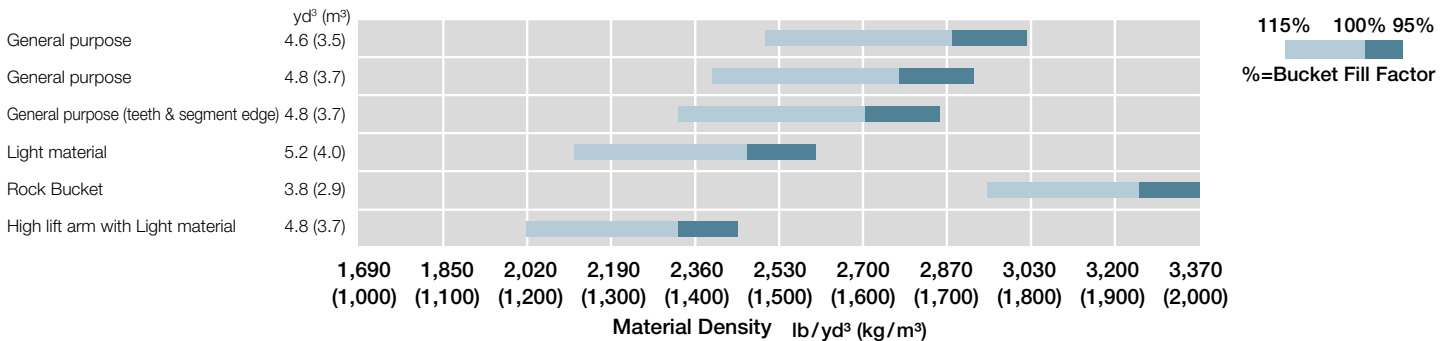

## STANDARD EQUIPMENT

### ENGINE

Air cleaner, double element
Auto idle shut down
Cold start (intake air heater)
Cooling fan, automatic reversible, swing-out type
Cummins QSB6.7 diesel engine
EGR System
Engine block heater 120V
Fuel filter (Main)
Fuel pre-filter, w/water separator
Pre-cleaner (SyKlone)
SCR (selective catalytic reduction) catalyst and DOC (diesel oxidation catalyst)
VGT (variable geometry turbocharger)
Work mode selector

### POWERTRAIN

Brakes, service
Enclosed wet disc
Dual system
Inboard mounted
Brake, parking
Spring applied
Oil pressure released
Dry disc type
Differential, limited slip type (F/R)
Down-shift switch
Drive shafts, low maintenance
Lock-up Torque Converter
F-R direction selector (2-column mounted/console mounted)
1st speed hold switch on side console
Quick Power switch
Transmission, automatic w/load sensing system.
Transmission declutch (3-position L/H/Off)
Transmission mode selection (3-position AUTO1/MAN/AUTO2)
Universal joints, sealed

### HYDRAULIC SYSTEM

3 spool valve
Boom kick-out, dual (operator adjustable in cab)
Bucket positioner (horizontal)
Control lever, dual, pilot-assisted
Control lever lock (electric)
Control valve, 2-spool, parallel and tandem control
Pump, variable displacement, load-sensing
Ride control w/load sensing valve and automatic shut-off
Steering, pilot
System; open-center, high-pressure, load-sensing
Valve, anti-drift

### ELECTRICAL

24-volt electrical system
Alternator (65 AMP)
Back-up alarm
Batteries (2), 12V, 930 CCA
Battery disconnect switch
Converter, 12V/15 Amp
Horn, dual electric
Instrument panel, LCD, color
Lights:
2 Headlights (halogen)
4 Forward working lights (LED)
4 Rear working lights (LED)
2 Stop/tail/backup (LED)
Turn signal w/4-way flashers/marker

### CAB

ROPS cab: enclosed cab with sound suppression, front & rear wipers and washers, two rear view and side mirrors, tinted glass, full view latch-back doors, sliding side windows.
Accessory outlet, 12v
Adjustable armrest/console
Air conditioner/heater/pressurizer
AM/FM/WB radio with AUX input and Bluetooth
Ashtray
Cab dome lamps (2)
Cigarette lighter, 24V
Coat hook
Cup holder (2)
Floormat, sweep-out
Retractable seat belt (3-inch)
ROPS/FOPS, ISO 3449 Level II compliant
Seat, deluxe heated w/TLV suspension
Steering column, telescoping and tilting w/quick-release pedal
Steering wheel
Storage box (heated/cooled)
Storage tray
Sun visor

### OTHERS

Articulation locking bar
Counterweight
Drawbar
Fire extinguisher, 5lb., 2A:10B:C rated (w/mounting) (US market only)
Global e-service, telematic monitoring system
Ladders, inclined
Lifting eyes
Linkage pins, HN bushing
Neutral safety start
Rear grill, hinged
Steps, rear
Vandalism protection
Z-bar loader linkage

### ALARMS, GAUGES, INDICATORS

Alarms (visual & audible)	Aftertreatment device
	Air cleaner element
	Axle oil temperature
	Battery discharge warning
	Brake oil low pressure
	CAN network system
	DEF/AdBlue tank level/quality/system
	Engine coolant temp
	Engine oil low pressure
	Engine overrun
	Engine trouble
	Engine warning
	Fuel filter (water in fuel)
	Hydraulic oil level
	Hydraulic oil temperature
	Main pump oil pressure
	Transmission oil temp Transmission warning
Gauges	DEF/AdBlue tank level
	Engine coolant temperature
	Fuel gauge
	Speedometer
	Tachometer
	Transmission oil temperature
Indicators	Aftertreatment device
	Air conditioner display
	Auto idle shutdown
	Boom kick-out, dual
	Cold start
	Control lever lock
	Declutch
	ECO-Operating Status
	Fan reverse rotation
	F-N-R Selection
	F-N-R Switch enable
	High beam
	Parking brake
	Shift hold
	Time/Operating hour/ODO
	Transmission mode and status
	Turn signal w/4-way flashers/Marker
	Work light
	Work mode (Normal, Power)

### OPTIONAL EQUIPMENT

Belly Guard, rear chassis
Belly guard, front chassis, transmission (rear)
Bolt-on cutting edge & segments
Bucket teeth
Cooling system cores, wide fin
E-Stick steering
Emergency steering system
Front and full covered rear fenders with mud flaps (23.5 Tire)
Front and half covered rear fenders with mud flaps (23.5 Tire)
Heated rear view mirror
High lift arm
Mount bracket, wiring harness and switch for rotating lamp (without beacon) (Canada Only)
Quick coupler & attachments
Rear view camera mount (high mount separated type)
Single lever hydraulic control

Standard and optional equipment may vary by country, so please consult your Hitachi dealer for details.



# HITACHI

Reliable solutions



REPUTATIONS ARE  
**BUILT ON IT.**

With manufacturing facilities in Banshu, Ryugasaki, Tierra, and Hitachinaka, Japan, and the U.S. corporate office and campus in Newnan, Georgia, Hitachi Construction Machinery Americas Inc. (HCMA) has the experience and technology to design, engineer, manufacture, and service your Hitachi construction machinery. The HCMA team is securely poised as your go-to source in the North American and Latin American construction machinery market.

Through our long-term commitment to maintaining a leadership position in technology, service, and support, HCMA supports an extensive network of independent, local dealers focused on providing you with knowledgeable and experienced sales, service, and parts personnel. All backed by dedicated HCMA support teams.

Your HCMA dealer has the resources, expertise and personnel to work with you to ensure that you receive the most benefit from your Hitachi investment utilizing carefully designed programs and services in conjunction with extensive digital resources. HCMA provides a totally focused approach to supporting you, your business, and your Hitachi construction machinery.

Machines representative of global product. Options may not be available in all markets. Prior to operating this machine, including satellite communication system, in a country other than a country of its intended use, it may be necessary to make modifications to it so that it complies with the local regulatory standards (including safety standards) and legal requirements of that particular country. Please do not export or operate this machine outside the country of its intended use until such compliance has been confirmed. Please contact your Hitachi dealer in case of questions about compliance.